

Novacucina

FLY&KXTON

FLY&KYTON

VALORI p. 2

Made in Italy.

Values. Made in Italy.

Valeurs. Fabriqué en Italie.

Valores. Hecha en Italia.

CUCINE p. 4

Eleganza e funzionalità per cucine protagoniste dello spazio.

Kitchens. Elegance and functionality for kitchens protagonists of the space.

Cuisines. Élégance et fonctionnalité pour les cuisines protagonistes de l'espace.

Cocinas. Elegancia y funcionalidad para cocinas protagonistas del espacio.

ZONA GIORNO p. 96

Uno stile coordinato per tutti gli ambienti della zona giorno.

Living area. Coordinated style for all rooms of living area.

Zone de vie. Style coordonné pour toutes les pièces de la zone de vie.

Zona de día. Un estilo coordinado para todos los ambientes de la zona de día.

ANTE E DETTAGLI TECNICI p. 116

La versatilità e la leggerezza delle nuove ante Kyton e Fly.

Doors and technical details. The versatility and lightness of the new Kyton and Fly doors.

Portes et détails techniques. L'éclectisme et la légèreté des nouvelles portes Kyton et Fly.

Puertas y detalles técnicos. La versatilidad y la ligereza de las nuevas puertas Kyton y Fly.

MATERIALI p. 118

Legno e pietra della tradizione incontrano i materiali più evoluti.

Materials. Traditional wood and stone meet the most advanced materials.

Matériaux. Le bois et la pierre de la traditionne rencontrent les matériaux les plus évolués.

Materiales. La madera y la piedra tradicionales descubren los materiales más avanzados.

VALORI

VALUES
VALEURS
VALORES

MADE IN ITALY

DIFFONDERE IL MADE IN ITALY È MOTIVO D'ORGOGGIO. SIGNIFICA DIFFONDERE LA PASSIONE PER GUSTO E DESIGN, L'ESPERIENZA DI UNA LUNGA TRADIZIONE NELL'ARREDO E IL PIACERE DI UN APPROCCIO ARTIGIANO, DOVE OGNI PROGETTO RICEVE MASSIMA ATTENZIONE CON UN PIZZICO DI ESCLUSIVITÀ. DA QUI NASCONO LE COLLABORAZIONI CON I MIGLIORI ARTIGIANI DEL TERRITORIO PER OFFRIRE PRODOTTI DI QUALITÀ IN OGNI DETTAGLIO.

TO SPREAD THE MADE IN ITALY LABEL IS SOMETHING WE ARE PROUD OF. IT MEANS SPREADING A PASSION FOR GOOD TASTE AND DESIGN, A LIFETIME EXPERIENCE OF FURNITURE MAKING AND THE PLEASURE OF A CRAFT APPROACH WHICH DEDICATES THE UTMOST ATTENTION TO EVERY PROJECT WITH A PINCH OF EXCLUSIVITY. ALL THIS GIVES RISE TO COOPERATION WITH THE BEST ARTISANS IN THE TERRITORY SO THAT OUR PRODUCTS INCORPORATE QUALITY IN EVERY DETAIL.

PROPAGER LE MADE IN ITALY EST UNE SOURCE DE FIERTÉ. CELA SIGNIFIE DIFFUSER LA PASSION PAR LE GOÛT ET LA CONCEPTION, L'EXPÉRIENCE D'UNE LONGUE TRADITION DANS L'AMEUBLEMENT ET LE PLAISIR D'UNE APPROCHE ARTISANALE, OÙ CHAQUE PROJET REÇOIT UN MAXIMUM D'ATTENTION AVEC UNE TOUCHE D'EXCLUSIVITÉ. DE CE POINT SONT NÉS DES COLLABORATIONS AVEC LES MEILLEURS ARTISANS DE LA RÉGION POUR OFFRIR DES PRODUITS DE QUALITÉ DANS LES MOINDRES DÉTAILS.

DIFUNDIR EL MADE IN ITALY ES UNA FUENTE DE ORGULLO. SIGNIFICA DIFUNDIR LA PASIÓN POR EL SABOR Y EL DISEÑO, LA EXPERIENCIA DE UNA LARGA TRADICIÓN EN MUEBLES Y EL PLACER DE UN ENFOQUE ARTESANAL, DONDE CADA PROYECTO RECIBE LA MÁXIMA ATENCIÓN CON UN TOQUE DE EXCLUSIVIDAD. ESTO DA LUGAR A COLABORACIONES CON LOS MEJORES ARTESANOS DE LA ZONA PARA OFRECER PRODUCTOS DE CALIDAD EN CADA DETALLE.



CUCINE
KITCHENS
CUISINE
COCINAS







Protagonista della cucina è l'isola operativa, che termina da un lato con il piano snack in noce tagliato a 45° e dall'altro con i pannelli in grès calacatta, posti in corrispondenza della zona cottura.

The operative island is the protagonist of the kitchen, which ends on one side with the walnut snack top cut at 45 ° and on the other side with the grès calacatta panels, placed at the cooking area.

L'îlot opératif est le protagoniste de la cuisine, qui termine d'un côté avec le plan snack en noyer coupé à 45 ° et de l'autre côté avec les panneaux en grès calacatta, placés dans la zone de cuisson.

La protagonista de la cocina es la isla operativa, que acaba con una barra de nogal cortada a 45° por un lado y, por el otro, con los paneles de gres Calacatta, situados en la zona de cocción.





Dietro le mensole, il grès calacatta dello schienale rende più luminosa la parete, composta di colonne in noce e colonne con ante in vetro fumé.

Behind the shelves, the grès calacatta of the back panel makes the wall brighter, composed of walnut columns and columns with smoked glass doors.

Derrière les étagères, le grès calacatta de la credence rend le mur plus lumineux, composé d'armoires en noyer et d'armoires avec portes en verre fumé.

Detrás de las ménsulas, el gres Calacatta del respaldo crea más luminosidad en la pared, compuesta por columnas de nogal y columnas con puertas de cristal ahumado.





Le colonne con ante in vetro fumé e telaio in alluminio nero sono dotate di illuminazione interna.

The columns with smoked glass doors and black aluminum frame are equipped with interior lighting.

Les armoires avec portes en verre fumé et cadre en aluminium noir sont équipées d'éclairage intérieur.

Las columnas, con puertas de cristal ahumado y estructura de aluminio negro, presentan una iluminación interna.



SCHEDA TECNICA CUCINA . 1
 TECHNICAL SHEET KITCHEN. 1
 FICHE TECHNIQUE CUISINE. 1
 FICHA TÉCNICA DE LA COCINA. 1

APERTURA A GOLA CLASSICA
 OPENING WITH CLASSIC GROOVE
 OUVERTURE AVEC GORGE CLASSIQUE
 APERTURA CON RANURA CLÁSICA

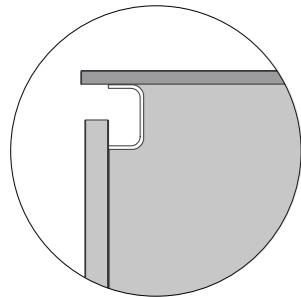

APERTURA PUSH-PULL
 OPENING WITH PUSH-PULL
 OUVERTURE AVEC PUSH-PULL
 APERTURA PUSH-PULL

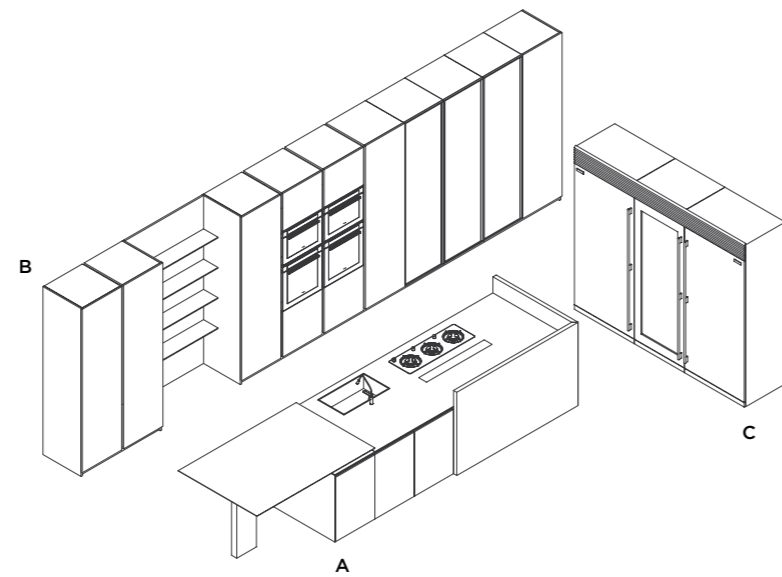
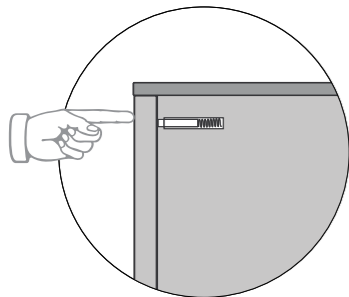

MATERIALI
 MATERIALS
 MATÉRIAUX
 MATERIALES



LACCATO OPACO
 BIANCO SOFT 201

NOCE CANALETTO

VETRO FUMÉ

PIANTA
 1 cucina
 2 living
 3 pranzo
 4 terrazzo

LAYOUT
 1 kitchen
 2 living
 3 lunch
 4 terrace

LAYOUT
 1 cuisine
 2 séjour
 3 déjeuner
 4 terrasse

PLANTA
 1 cocina
 2 living
 3 comedor
 4 terraza

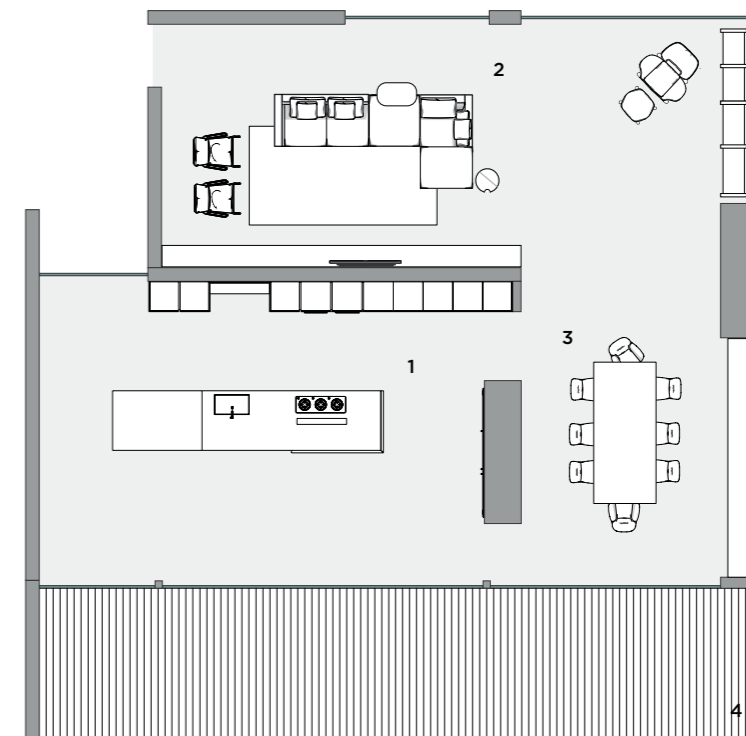

A | ISOLA
 island
 îlot
 isla

B | COLONNE
 tall units
 armoires
 columnas

C | COLONNA FRIGO
 fridge tall unit
 armoire frigo
 columna frigorífico

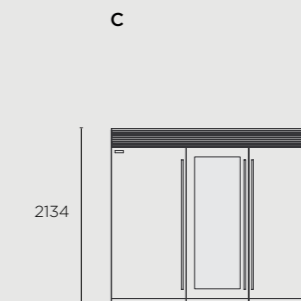
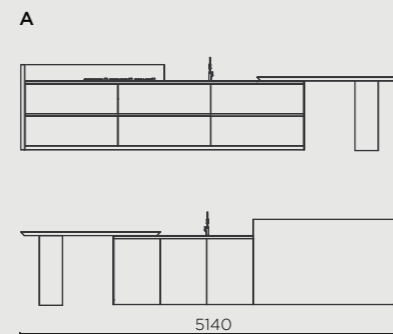





CUCINA . 2 KITCHEN . 2 CUISINE . 2 COCINA . 2

LA CUCINA È PROGETTATA IN FUNZIONE DELLO SPAZIO ARCHITETTONICO CHE LA OSPITA. SULLA PARETE DI FONDO CI SONO LE COLONNE E, SOTTO LA FINESTRA, LE BASI IN LACCATO BIANCO TRAFFICO 9016 CON TOP IN PIETRA GREY. DI FRONTE, IN APPOGGIO ALLA BOISERIE CON MENSOLE IN ROVERE TERMOCOTTO, C'È LA PENISOLA OPERATIVA.

THE KITCHEN IS DESIGNED ACCORDING TO THE ARCHITECTURAL SPACE THAT HOUSES IT. ON THE BACK WALL THERE ARE THE TALL UNITS AND, UNDER THE WINDOW, THE LIGHT GRAY LACQUERED BASE UNITS WITH BIANCO TRAFFICO 9016 WORKTOP. OPPOSITE, IN SUPPORT OF THE BOISERIE WITH THERMOCOOKED OAK SHELVES, THERE IS THE OPERATIVE PENINSULA.

LA CUISINE EST CONÇUE EN FONCTION DE L'ESPACE ARCHITECTURAL QUI L'ABRITE. SUR LE MUR DU FOND, IL Y A LES ARMOIRES ET, SOUS LA FENÊTRE, LES MEUBLES BASE LAQUÉES BIANCO TRAFFICO 9016 AVEC LE PLAN DE TRAVAIL EN PIERRE GRISE. EN FACE, À L'APPUI DE LA BOISERIE AVEC DES ÉTAGÈRES EN CHÊNE THERMO-CUIT, IL Y A LA PÉNINSULE OPÉRATIONNELLE.

LA COCINA SE HA DISEÑADO EN FUNCIÓN DEL ESPACIO ARQUITECTÓNICO DONDE SE ALOJA. EN LA PARED DEL FONDO, HAY COLUMNAS Y, BAJO LA VENTANA, LAS BASES ESTÁN LACADAS EN BIANCO TRAFFICO 9016 CON ENCIMERA DE PIEDRA GREY. EN LA PARTE DELANTERA, ENCONTRAMOS LA PENÍNSULA OPERATIVA APOYADA EN LA BOISERIE CON MÉNSULAS DE ROBLE TERMOCOCIDO.





Di fronte alla cucina si apre l'ampia sala da pranzo. Il modulo sospeso della parete di fondo è anch'esso parte della collezione.

In front of the kitchen opens the large dining room. The suspended module of the back wall is also part of the collection.

Devant la cuisine s'ouvre la grande salle à manger. Le module suspendu de la paroi arrière fait également partie de la collection.

Delante de la cocina se abre el amplio comedor. El módulo suspendido de la pared del fondo forma parte también de la colección.

L'ambiente cucina è suddiviso in due spazi contigui e complementari. Dietro i pannelli scorrevoli in legno c'è una seconda cucina operativa con dispensa e zona cottura, da chiudere all'occorrenza.

The kitchen area is divided into two contiguous and complementary spaces. Behind the sliding wooden panels there is a second operative kitchen with pantry and cooking area, to be closed if necessary.

Le coin cuisine est divisé en deux espaces contigus et complémentaires. Derrière les panneaux coulissants en bois, il y a une deuxième cuisine opérationnelle avec garde-manger et zone de cuisson, à fermer si nécessaire.

El ambiente de la cocina se divide en dos espacios contiguos y complementarios. Detrás de los paneles correderos de madera, encontramos una segunda cocina operativa con despensa y zona de cocción, que puede cerrarse.





SCHEMA TECNICA CUCINA . 2
 TECHNICAL SHEET KITCHEN. 2
 FICHE TECHNIQUE CUISINE. 2
 FICHA TÉCNICA DE LA COCINA. 2

APERTURA A GOLA PIATTA
 OPENING WITH FLAT GROOVE
 OUVERTURE AVEC GORGE PLATE
 APERTURA CON RANURA PLANA

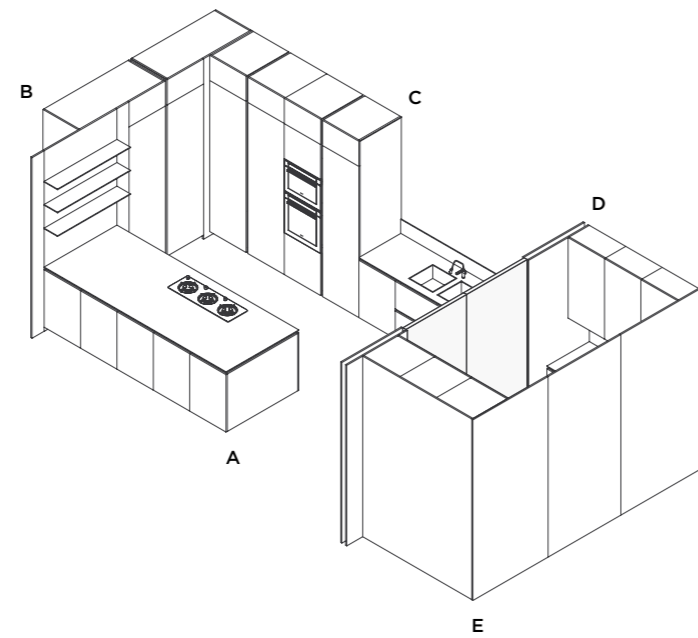
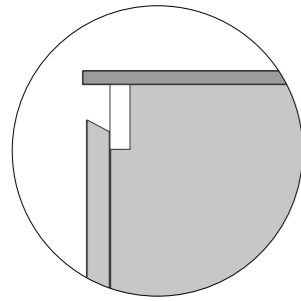

MATERIALI
 MATERIALS
 MATÉRIAUX
 MATERIALES

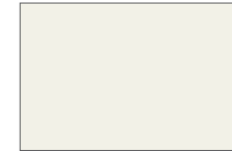

LACCATO OPACO
 BIANCO TRAFFICO 9016

ROVERE
 TERMOCOTTO

PIANTA
 1 cucina
 2 living
 3 pranzo

LAYOUT
 1 kitchen
 2 living
 3 lunch

LAYOUT
 1 cuisine
 2 séjour
 3 déjeuner

PLANTA
 1 cocina
 2 living
 3 comedor

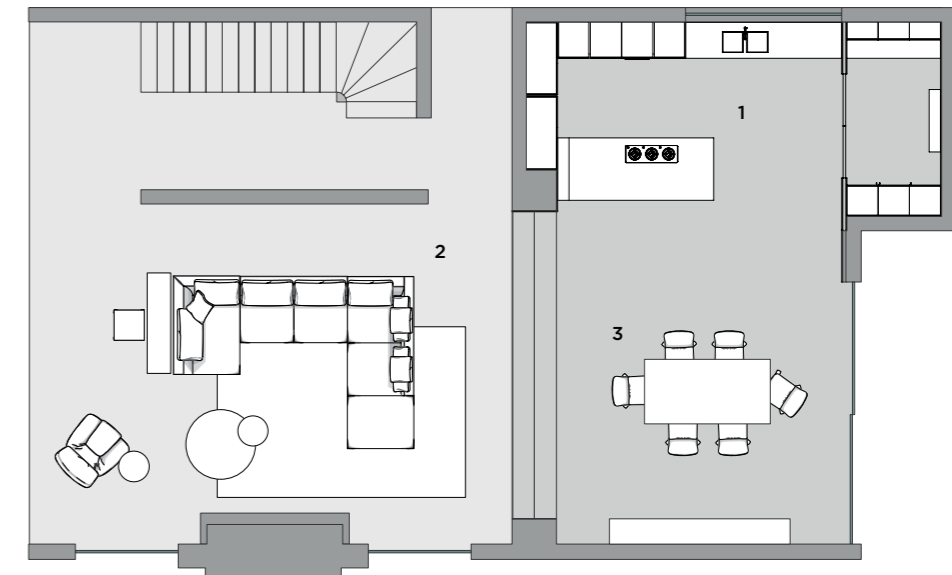

A | ISOLA

island
 îlot
 isla

B | COLONNE

tall units
 armoires
 columns

C | COLONNE E BASI A PARETE

tall unit and base units
 armoires et meubles bas
 columns y bases murales

D | ZONA OPERATIVA

operative area
 zone opérationnelle
 zona operativa

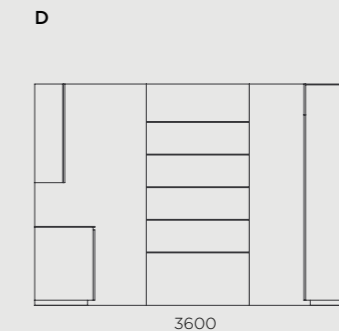
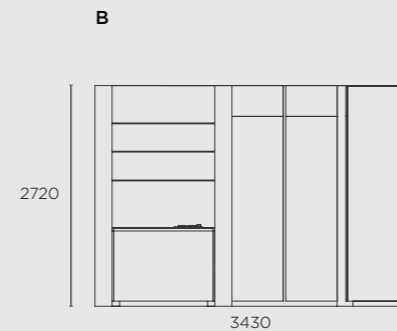
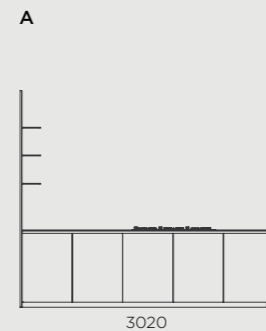

CUCINA . 3 KITCHEN . 3 CUISINE . 2 COCINA . 3

IN UN COMPLESSO RESIDENZIALE DALLE LINEE CONTEMPORANEE, GLI INTERNI RISPESCHIANO L'ISPIRAZIONE MINIMALISTA DELL'ARCHITETTURA. LA CUCINA, CHE SI APRE SULLA SALA DA PRANZO, È GIOCATO SU COLORI NEUTRI E RISCALDATA DAL LEGNO DI BRICCOLA, UN MATERIALE NATURALE E VISSUTO CHE DÀ UN TOCCO PARTICOLARE ALL'AMBIENTE.

IN A RESIDENTIAL PLAN WITH CONTEMPORARY LINES, THE INTERIORS REFLECT THE MINIMALIST INSPIRATION OF THE ARCHITECTURE. THE KITCHEN, WHICH OPENS INTO THE DINING ROOM, IS PLAYED ON NEUTRAL COLORS AND HEATED BY WOOD OF BRICCOLA, A NATURAL AND LIVED MATERIAL THAT GIVES A SPECIAL TOUCH TO THE ROOM.

DANS UN COMPLEXE RÉSIDENTIEL AUX LIGNES CONTEMPORAINES, LES INTÉRIEURS REFLÈTENT L'INSPIRATION MINIMALISTE DE L'ARCHITECTURE. LA CUISINE, QUI S'OUVRE SUR LA SALLE À MANGER, EST JOUÉE SUR DES COULEURS NEUTRES ET CHAUFFÉE PAR DU BOIS DE BRICCOLA, UN MATÉRIAU NATUREL ET VÉCU QUI DONNE UNE TOUCHE SPÉCIALE À L'ENVIRONNEMENT.

EN UN COMPLEJO RESIDENCIAL CON LÍNEAS CONTEMPORÁNEAS, LOS INTERIORES REFLEJAN LA INSPIRACIÓN MINIMALISTA DE LA ARQUITECTURA. LA COCINA, ABIERTA AL COMEDOR, JUEGA CON COLORES NEUTROS Y RESULTA CÁLIDA CON EL EMPLEO DE LA MADERA DE BRICCOLA, UN MATERIAL NATURAL Y CON HISTORIA PARA IMPRIMIR UN TOQUE PARTICULAR AL AMBIENTE.







In questa cucina convivono due tipi di apertura: quella con maniglia M1150 per le ante delle basi e quella con maniglia scavata M803 per le ante delle colonne.

In this kitchen there are two types of openings: the one with the M1150 handle for the doors of the base units and the one with built-in M803 handle for the doors of the tall units.

Dans cette cuisine il y a deux types d'ouvertures: celle avec la poignée M1150 pour les portes des meubles base et celle avec poignée encastrée M803 pour les portes des armoires.

En esta cocina conviven dos tipos de apertura: con el tirador M1150 para las puertas de las bases y con el tirador cóncavo M803 para las puertas de las columnas.





Per utensili e accessori, oltre all'attrezzatura sottopensile in alluminio nero ci sono gli elementi magnetici, attirati dal fondo calamitato dello schienale in vetro bianco.

For tools and accessories, in addition to the fitted black aluminum wall system under the wall units there are magnetic elements, attracted by the magnetized back of the white glass back panel.

Pour les outils et accessoires, outre l'équipement sous les meubles haut en aluminium noir, il y a les éléments magnétiques attirés par le fond magnétisé de la crédence en verre blanc.

Para colocar los enseres y los accesorios, junto a la estructura bajo los elementos colgantes de aluminio negro, hay también elementos magnéticos, que se sostienen en el fondo con imán del respaldo de cristal blanco.





Il passaggio dalla cucina alla sala da pranzo è reso armonioso dalle colonne in ardesia, usate in continuità. Tra le colonne è stata ricavata una porta scorrevole che conduce a una zona di servizio.

The passage from the kitchen to the dining room is made harmonious by the slate tall units, used in continuity. Between the tall units a sliding door has been created that leads to a service area.

Le passage de la cuisine à la salle à manger est harmonisé par les armoires en ardoise, utilisées en continuité. Entre les armoires, une porte coulissante a été créée qui mène à une zone de service.

Las columnas de pizarra, usadas en continuidad, armonizan el paso de la cocina al comedor. Entre las columnas se ha obtenido una puerta corredera para ir a una zona de servicio.

SCHEDA TECNICA CUCINA . 3
 TECHNICAL SHEET KITCHEN . 3
 FICHE TECHNIQUE CUISINE . 3
 FICHA TÉCNICA DE LA COCINA . 3

APERTURA CON MANIGLIA
 OPENING WITH HANDLE
 OUVERTURE AVEC POIGNÉE
 APERTURA CON TIRADOR

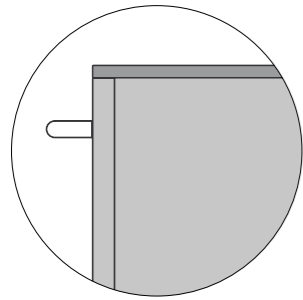

APERTURA CON MANIGLIA SCAVATA
 OPENING WITH BUILT-IN HANDLE
 OUVERTURE AVEC POIGNÉE ENCASTRÉE
 APERTURA CON TIRADOR CÓNCAVO

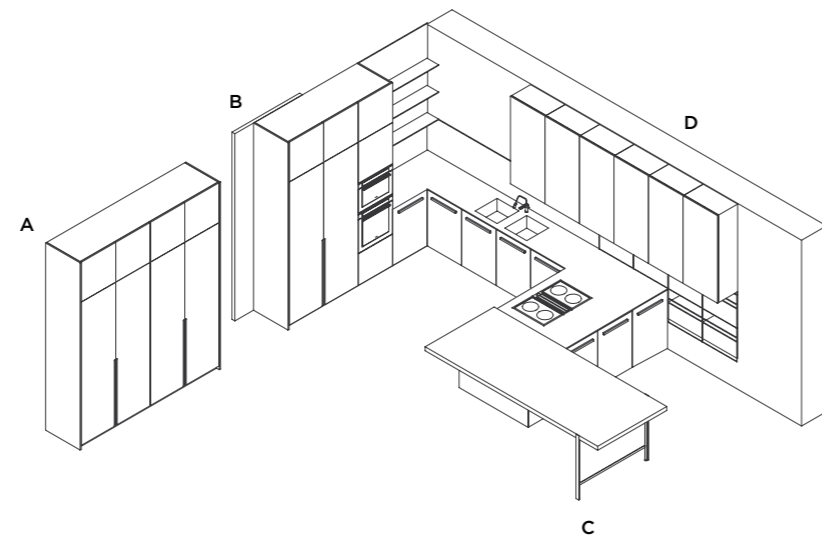
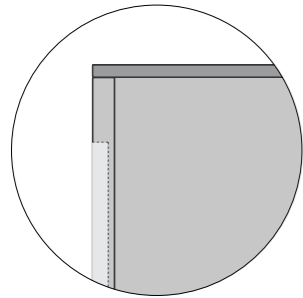

MATERIALI
 MATERIALS
 MATÉRIAUX
 MATERIALES



LACCATO OPACO
 BIANCO SOFT 201



LACCATO OPACO
 ARDESIA 220



LEGNO DI BRICCOLA
 NATURALE

PIANTA
 1 cucina
 2 living
 3 pranzo
 4 terrazzo

LAYOUT
 1 kitchen
 2 living
 3 lunch
 4 terrace

LAYOUT
 1 cuisine
 2 séjour
 3 déjeuner
 4 terrasse

PLANTA
 1 cocina
 2 living
 3 comedor
 4 terraza

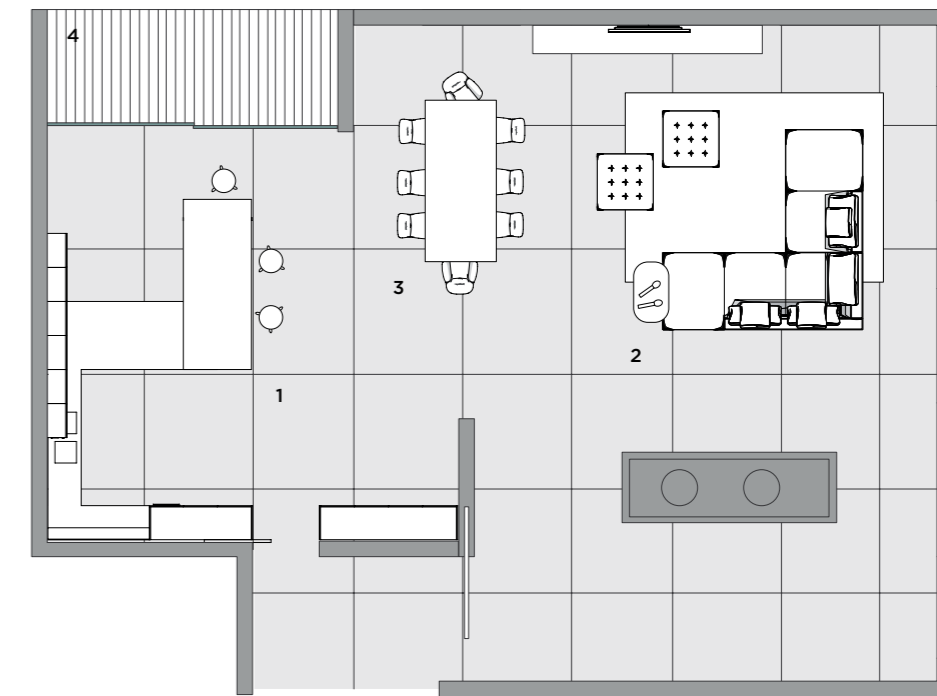

A | COLONNE

tall units
 armoires
 columnas

B | COLONNE E BASI A PARETE

tall unit and base units
 armoires et meubles bas
 columnas y bases murales

C | PENISOLA E PIANO SNACK

peninsula and snack work top
 péninsule et plan snack
 península y barra

D | PENSILI

wall units
 meubles haut
 elementos colgantes

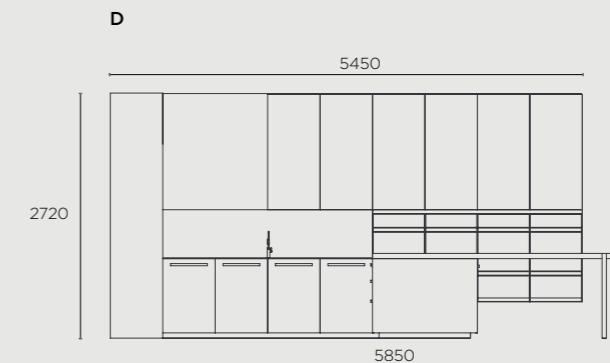
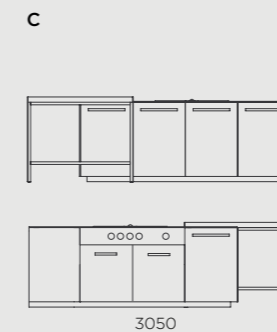
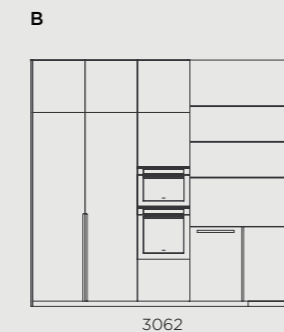
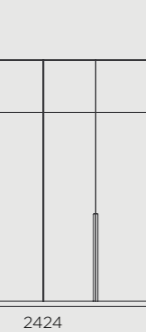





CUCINA . 4 KITCHEN . 4 CUISINE . 4 COCINA . 4

HA UN ASPETTO PROFESSIONALE EPPURE FAMILIARE LA CUCINA CON ISOLA, CAPPA E BASI A PARETE IN ACCIAIO INOX E COLONNE IN LACCATO METALLO FERRO NATURALE E ABETE MOKA, UN LEGNO VISSUTO E CONSUNTO CHE DÀ UN TOCCO DI CALORE ALL'AMBIENTE.

THE KITCHEN HAS A PROFESSIONAL YET FAMILIAR APPEARANCE WITH ISLAND, HOOD AND STAINLESS STEEL BASE UNITS AND THE TALL UNITS IN NATURAL IRON METAL LACQUERED AND MOKA FIR, A LIVED AND WORN WOOD THAT GIVES A TOUCH OF WARMTH TO THE ENVIRONMENT.

LA CUISINE AVEC ÎLOT, HOTTE ET MEUBLES BASE EN ACIER INOXYDABLE A UN ASPECT PROFESSIONNEL MAIS FAMILIER ET LES ARMOIRES LAQUÉES EN MÉTAL FER NATUREL ET SAPIN MOKA, UN BOIS VÉCU ET USÉ QUI DONNE UNE TOUCHE DE CHALEUR À L'ENVIRONNEMENT.

PRESENTA UN ASPECTO PROFESIONAL PERO TAMBIÉN FAMILIAR LA COCINA CON ISLA, EXTRACTOR Y BASES MURALES DE ACERO INOXIDABLE Y COLUMNAS LACADAS EN FERRO NATURALE Y ABETO MOKA, UNA MADERA CON HISTORIA Y USADA, QUE IMPRIME UN TOQUE DE CALIDEZ AL AMBIENTE.





L'acciaio inox dell'isola centrale e delle basi a parete è ripreso dagli elettrodomestici e dall'anta della cantina vini, inserita nelle colonne in laccato metallo ferro naturale.

The stainless steel of the central island and the wall base units is taken up by the appliances and the door of the wine cellar, inserted in the tall units in lacquered metal iron finish.

L'acier inoxydable de l'îlot central et des meubles base est repris par les électroménagers et la porte de la cave à vin, insérée dans les armoires en métal laqué finition fer.

El acero inoxidable de la isla central y de las bases murales se retoma en los electrodomésticos y en la puerta de la bodega para vinos, insertada en las columnas lacadas con acabado ferro naturale.





La cucina vista dal living. Il focus è tutto sull'isola centrale, un monoblocco d'acciaio su cui è sospesa la grande cappa decorata con piante.

The kitchen seen from the living room. The focus is all on the central island, a steel monoblock on which the large hood decorated with plants is suspended.

La cuisine vue du salon. L'accent est mis sur l'îlot central, un monobloc en acier sur lequel est suspendue grande hotte décorée avec plantes.

La cocina vista desde el living. La atención se concentra completamente en la isla central, un monobloque de acero sobre el que cuelga un gran extractor decorado con plantas.

Le colonne a spessore ridotto in abete moka sono intervallate dalla boiserie con mensole in laccato metallo ferro naturale.

The moka fir tall units with reduced thickness are alternating with the boiserie with shelves in natural iron metal lacquered.

Les armoires en sapin moka à épaisseur réduite sont entrecoupées de la boiserie avec des étagères laquées métal fer naturel.

Entre las columnas finas de abeto moka se intercala la boiserie con ménsulas lacadas en ferro naturale.



SCHEMA TECNICA CUCINA . 4

TECHNICAL SHEET KITCHEN. 4

FICHE TECHNIQUE CUISINE. 4

FICHA TÉCNICA DE LA COCINA. 4

APERTURA A GOLA CLASSICA

OPENING WITH CLASSIC GROOVE

OUVERTURE AVEC GORGE CLASSIQUE

APERTURA CON RANURA CLÁSICA

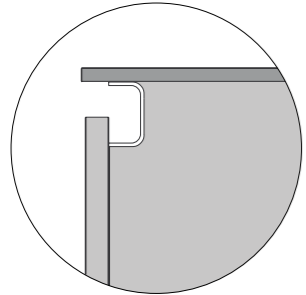

APERTURA PUSH-PULL

OPENING WITH PUSH-PULL

OUVERTURE AVEC PUSH-PULL

APERTURA PUSH-PULL

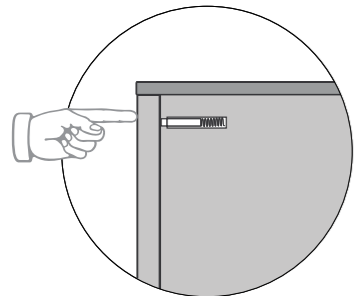

APERTURA A MANIGLIA

OPENING WITH HANDLE

OUVERTURE AVEC POIGNÉE

APERTURA CON TIRADOR

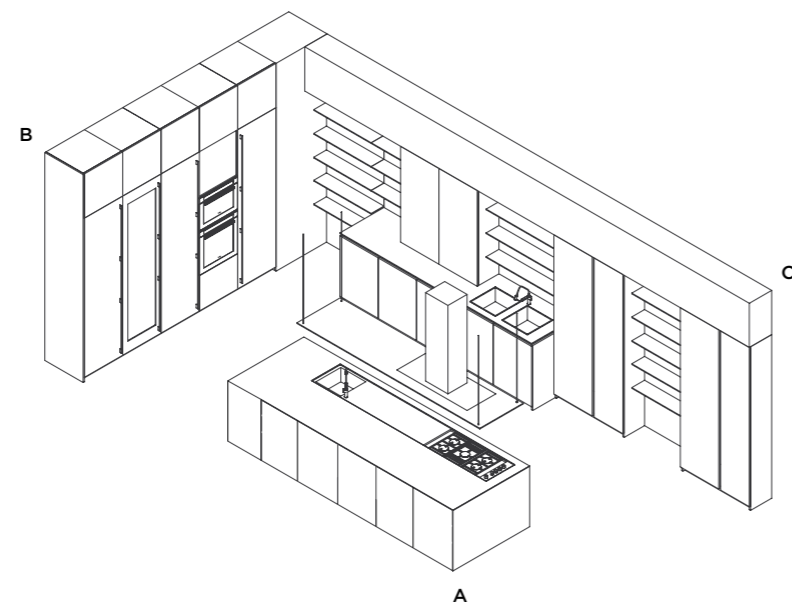
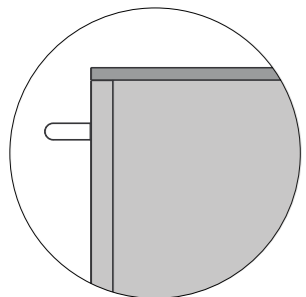

MATERIALI

MATERIALS

MATÉRIAUX

MATERIALES



INOX



ABETE MOKA



LACCATO METALLO
FERRO NATURALE

PIANTA

1 cucina

2 pranzo

3 living

LAYOUT

1 kitchen

2 lunch

3 living

LAYOUT

1 cuisine

2 déjeuner

3 séjour

PLANTA

1 cocina

2 comedor

3 living

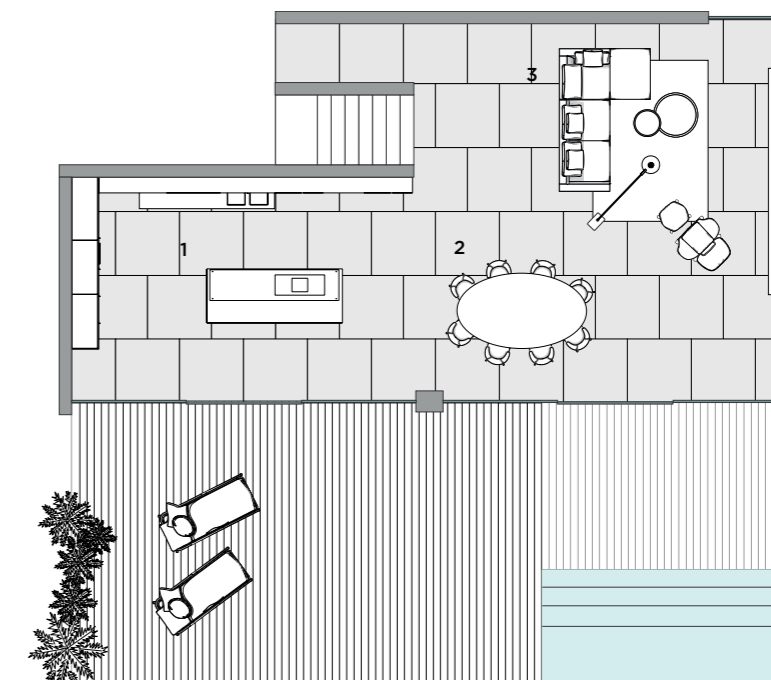

A | ISOLA

island

îlot

isla

B | COLONNE

tall units

armoires

columnas

C | COLONNE, BASI E BOISERIE A PARETE

tall unit, base and boiserie units against wall

armoires, meubles bas et boiserie

columnas, bases y boiserie murales

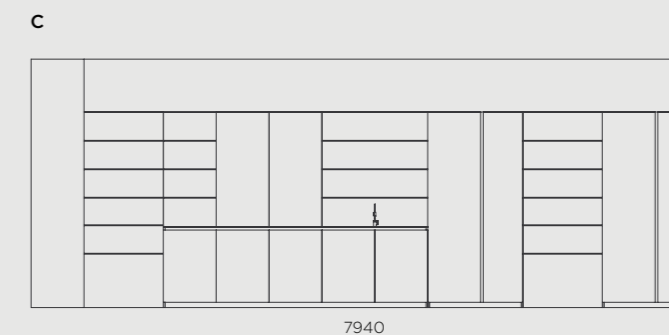
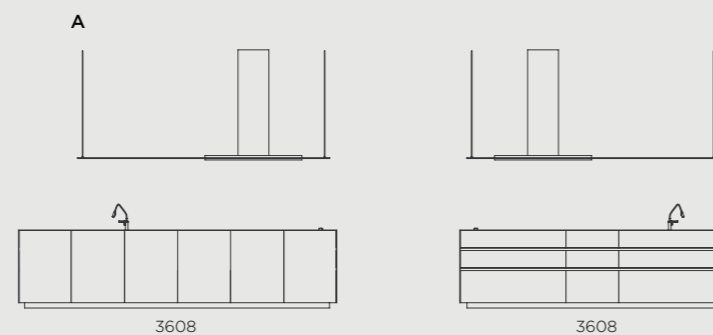



CUCINA . 5 KITCHEN . 5 CUISINE . 5 COCINA . 5

DIETRO LE AMPIE VETRATE CHE GUARDANO AL PATIO CON PISCINA, LA CUCINA DI UNA VILLA MODERNA SI SVILUPPA LONGITUDINALMENTE. A PARETE, LE COLONNE ATTREZZATE SONO INTERROTTE DALLE BASI CON ZONA COTTURA, MENTRE SULL'AMPIA ISOLA CENTRALE TROVANO POSTO IL LAVABO E IL PIANO SNACK TRASLANTE.

BEHIND THE LARGE WINDOWS OVERLOOKING THE PATIO WITH SWIMMING POOL, THE KITCHEN OF A MODERN VILLA DEVELOPS LONGITUDINALLY. ON THE WALL, THE EQUIPPED TALL UNITS ARE INTERRUPTED BY THE BASE UNITS WITH A COOKING AREA, WHILE ON THE LARGE CENTRAL ISLAND THERE IS A SINK AND A MOVING SNACK WORKTOP.

DERRIÈRE LES GRANDES BAIES VITRÉES DONNANT SUR LE PATIO AVEC PISCINE, LA CUISINE D'UNE VILLA MODERNE SE DÉVELOPPE LONGITUDINALEMENT. SUR LE MUR, LES ARMOIRES ÉQUIPÉES SONT INTERROMPUES PAR LES MEUBLES BASE AVEC ZONE DE CUISSON, ALORS QUE SUR LE GRAND ÎLOT CENTRAL SE TROUVENT UN ÉVIER ET UN PLAN SNACK MOBILE.

TRAS LAS GRANDES CRISTALERAS, QUE DAN AL PATIO CON PISCINA, LA COCINA DE UN CHALET MODERNO SE DESARROLLA LONGITUDINALMENTE. EN LA PARED, LAS COLUMNAS EQUIPADAS SE INTERRUMPEN CON LAS BASES DE LA ZONA DE COCCIÓN; MIENTRAS QUE EN LA AMPLIA ISLA CENTRAL ENCONTRAMOS EL FREGADERO Y LA BARRA MÓVIL.



Il piano snack si sposta grazie a un meccanismo traslante: chiuso è perfettamente allineato all'isola, aperto è ideale per colazioni e piccoli pasti.

The snack table moves thanks to a translating mechanism: closed is perfectly aligned with the island, open is ideal for breakfasts and small meals

La plan snack se déplace grâce à un mécanisme de translation: fermé et parfaitement aligné avec l'îlot, ouvert est idéal pour les petits déjeuners et les petits repas.

La barra se desplaza mediante un mecanismo de traslación: cerrada, resulta perfectamente alineada con la isla y abierta es ideal para desayunos y comidas ligeras.

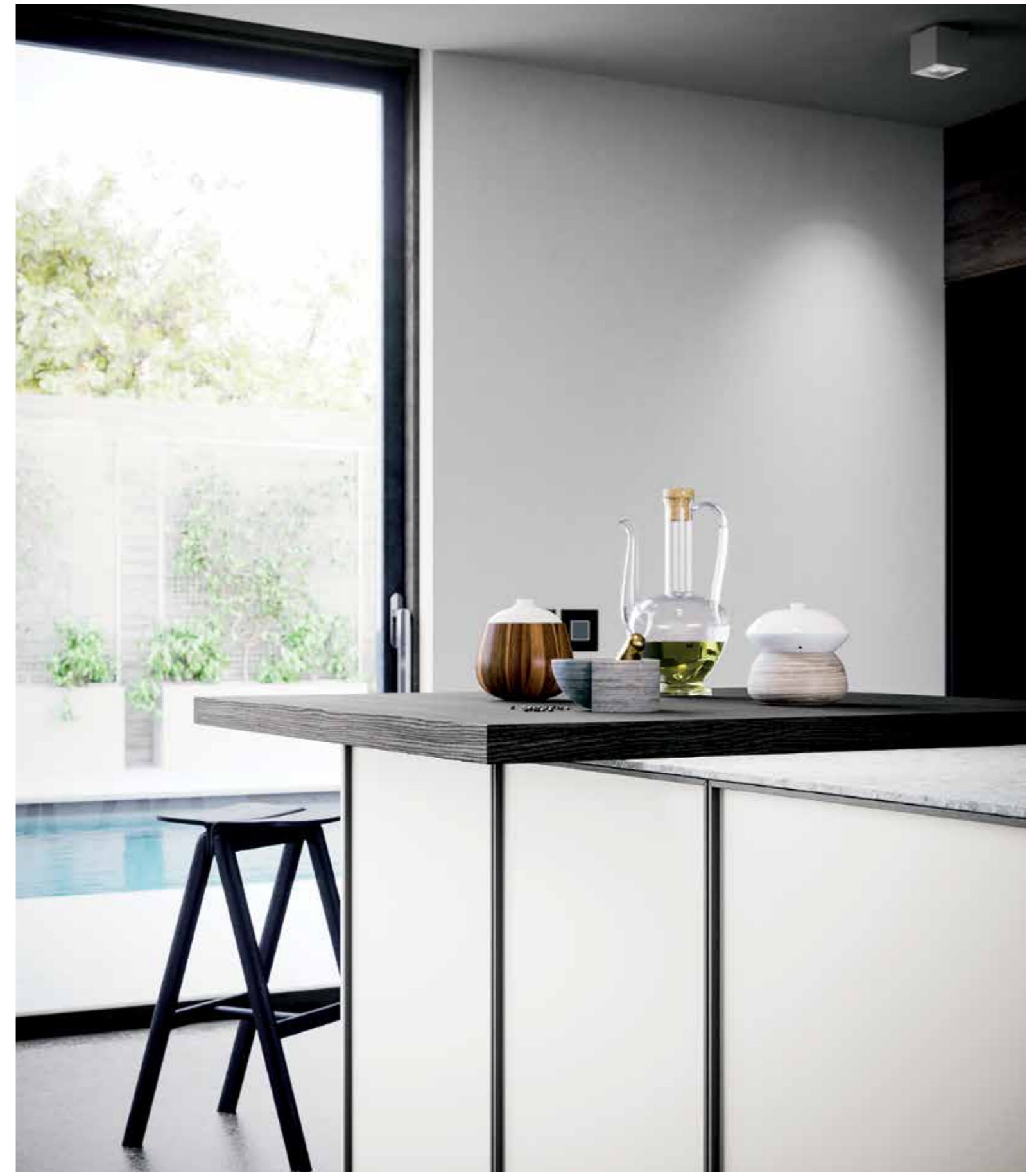



Gli interni delle colonne in rovere Karbon sono in finitura antracite e possono essere dotati di illuminazione a LED.

The interiors of the Karbon oak tall units are in anthracite finishing and can be equipped with LED lighting.

Les intérieurs des armoires en chêne Karbon sont en finition anthracite et peuvent être équipés d'un éclairage LED.

Los interiores de las columnas de roble Karbon presentan un acabado antracita y se pueden iluminar con LED.



Il nuovo telaio in alluminio spesso otto millimetri incornicia il pannello dell'anta, qui in finitura rovere Karbon.

The new eight-millimeter thick aluminum frame frames the door panel, here in carbon oak finishing.

Le nouveau cadre en aluminium de huit millimètres encadre le panneau de la porte, ici en finition chêne carbon.

La nueva estructura de aluminio de ocho milímetros de grosor enmarca el panel de la puerta, con acabado roble carbon en este caso.



Il top con lavabo integrato è in pietra di Gré, un materiale tradizionale tipico dell'architettura milanese che si sposa con il rovere Karbon del piano snack.

The worktop with integrated sink is in Gré stone, a traditional material typical of Milanese architecture that blends with the Karbon oak of the snack worktop.

Le plan de travail avec évier intégré est en pierre Gré, un matériau traditionnel typique de l'architecture milanaise qui s'harmonise avec le le finition chêne Karbon de le plan snack.

La encimera con fregadero integrado es de piedra de Gré, un material tradicional, típico de la arquitectura de Milán, que encaja perfectamente con el roble Karbon de la barra.

SCHEDA TECNICA CUCINA . 5

TECHNICAL SHEET KITCHEN. 5
FICHE TECHNIQUE CUISINE. 5
FICHA TÉCNICA DE LA COCINA. 5

APERTURA SISTEMA TELAIO

FRAME SYSTEM OPENING
OUVERTURE DU SYSTÈME DE CADRE
SISTEMA DE MARCO DE APERTURA

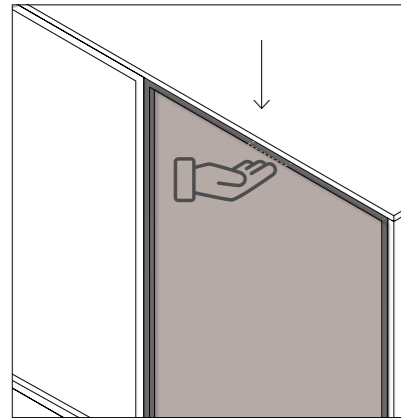
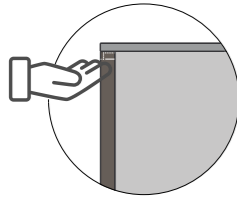

APERTURA PUSH-PULL
OPENING WITH PUSH-PULL
OUVERTURE AVEC PUSH-PULL
APERTURA PUSH-PULL

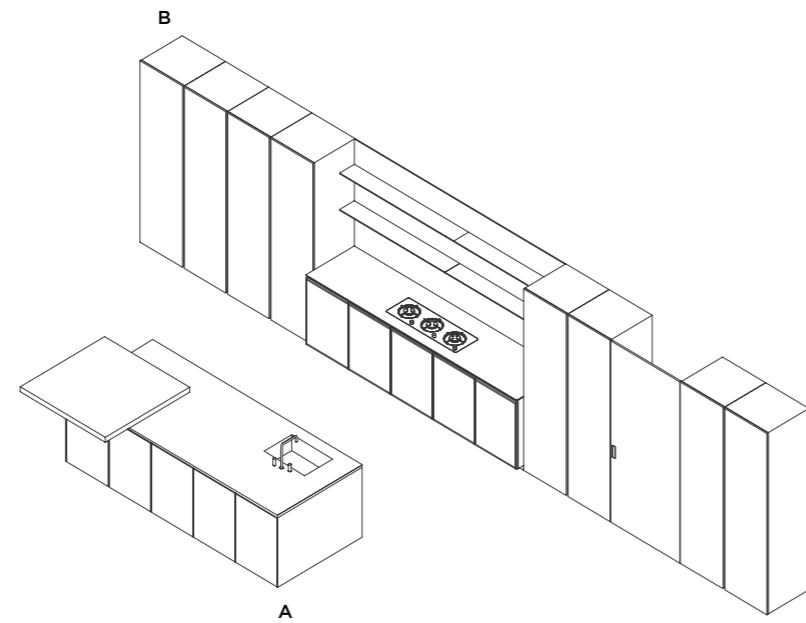
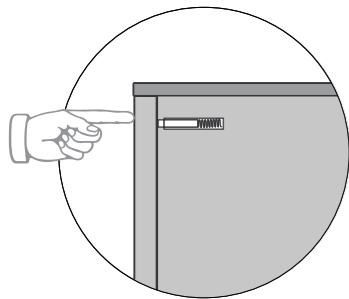

MATERIALI
MATERIALS
MATÉRIAUX
MATERIALS



LACCATO OPACO
BIANCO TRAFFICO 9016



ROVERE KARBON

PIANTA
1 cucina
2 living
3 pranzo

LAYOUT
1 kitchen
2 living
3 lunch

LAYOUT
1 cuisine
2 séjour
3 déjeuner

PLANTA
1 cocina
2 living
3 comedor

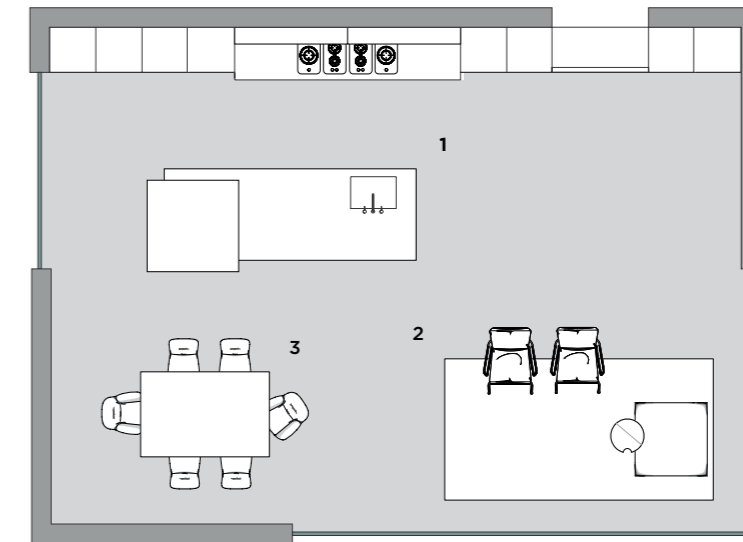

A | ISOLA

island
îlot
isla

B | COLONNE E BASI A PARETE

tall unit and base units
armoires et meubles haut
columnas y bases murales

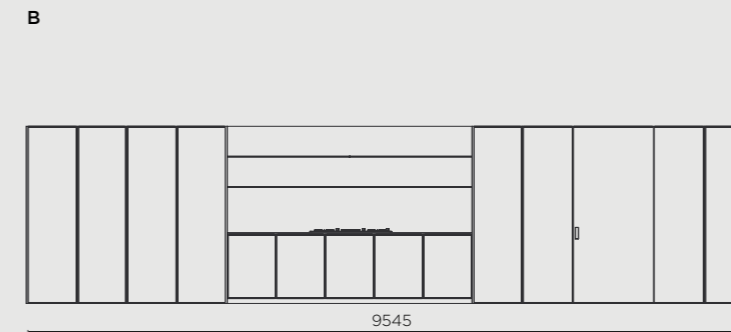
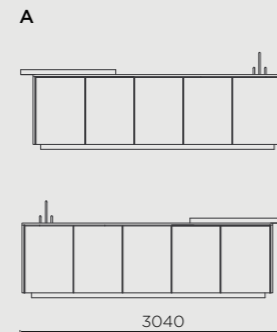

CUCINA . 6 KITCHEN . 6 CUISINE . 6 COCINA . 6

IN UN LOFT RICAVATO ALL'INTERNO DI UN VECCHIO COMPLESSO PRODUTTIVO, GLI INTERNI PORTANO LE TRACCE DELL'ANTICA DESTINAZIONE INDUSTRIALE, DAL PAVIMENTO IN CEMENTO ALLE GRANDI FINESTRE, FINO ALLA SCELTA DEI COLORI DELLA CUCINA, DOMINATA DAL NERO E DAL ROVERE NATURALE.

IN A LOFT CREATED INSIDE AN OLD PRODUCTIVE PLANT, THE INTERIORS BRING TRACES OF THE ANCIENT INDUSTRIAL DESTINATION, FROM THE CEMENT FLOOR TO THE LARGE WINDOWS, UP TO THE CHOICE OF COLORS OF THE KITCHEN, DOMINATED BY BLACK AND NATURAL OAK.

DANS UN LOFT SITUÉ DANS UN ANCIEN COMPLEXE DE PRODUCTION, LES INTÉRIEURS APPORTENT DES TRACES DE L'ANCIENNE DESTINATION INDUSTRIELLE, DU SOL EN BÉTON AUX GRANDES FENÊTRES, JUSQU'AU CHOIX DES COULEURS DE LA CUISINE, DOMINÉES PAR LE NOIR ET LE CHÊNE NATUREL.

EN UN LOFT, SITUADO EN UN VIEJO COMPLEJO DE PRODUCCIÓN, LOS INTERIORES MUESTRAN LAS HUELLAS DEL ANTIGUO USO INDUSTRIAL, EL PAVIMENTO DE CEMENTO, LAS VENTANAS GRANDES Y LA ELECCIÓN DE LOS COLORES DE LA COCINA, DOMINADA POR EL NEGRO Y EL ROBLE NATURAL.





UN AMBIENTE DALLE DIMENSIONI IMPONENTI, CON LA CUCINA SVILUPPATA ATTORNO ALL'ISOLA CENTRALE A DOPPIA ALTEZZA E TAVOLO IN APPOGGIO. SULLA PARETE DI FONDO, LE BASI SONO IN VETRO SATINATO NERO MENTRE I PENSILI SONO IN ROVERE NATURALE, COME LE COLONNE A DOPPIA ALTEZZA.

AN ENVIRONMENT OF IMPRESSIVE DIMENSIONS, WITH THE KITCHEN DEVELOPED AROUND THE CENTRAL ISLAND WITH DOUBLE HEIGHT AND TABLE IN SUPPORT. ON THE BACK WALL, THE BASE UNITS ARE IN BLACK SATIN GLASS WHILE THE WALL UNITS ARE IN NATURAL OAK, LIKE THE DOUBLE HEIGHT TALL UNITS.

UN ENVIRONNEMENT DE DIMENSIONS IMPRESSIONNANTES, AVEC LA CUISINE DÉVELOPPÉE AUTOUR DE L'ÎLOT CENTRAL AVEC DOUBLE HAUTEUR ET TABLE EN APPUI. SUR LE MUR DU FOND, LES MEUBLES BASE SONT EN VERRE DÉPOLI NOIR ALORS QUE LES MEUBLES HAUT SONT EN CHÊNE NATUREL, COMME LES ARMOIRES À DOUBLE HAUTEUR.

UN AMBIENTE CON DIMENSIONES IMPONENTES, CON LA COCINA DESARROLLADA ALREDEDOR DE LA ISLA CENTRAL CON ALTURA DOBLE Y MESA DE APOYO. EN LA PARED DEL FONDO, LAS BASES SON DE CRISTAL SATINADO NEGRO Y LOS ELEMENTOS COLGANTES DE ROBLE NATURAL COMO LAS COLUMNAS DE DOBLE ALTURA.





Come l'isola, sono in vetro satinato nero anche le basi operative, con lavello in acciaio incassato a filotop.

Like the island, the operative base units are also in black satin glass, with a flush-mounted steel sink.

Comme l'îlot, les meubles base opérationnels sont également en verre satiné noir, avec évier en acier encastré à fleur du plan.

Al igual que la isla, también las bases operativas son de cristal satinado negro, con fregadero de acero encajado a ras.



La particolarità dell'isola è l'apertura a gola, unica per il cassetto superiore e per quello inferiore.

The peculiarity of the island is the groove opening, single for the upper drawer and the lower drawer.

La particularité de l'îlot est l'ouverture avec gorge, unique pour le tiroir supérieur et le tiroir inférieur.

La peculiaridad de la isla es la apertura con ranura, única para el cajón superior y para el inferior.





**Le colonne a doppia altezza sono in rovere naturale,
una finitura che crea un abbinamento molto espressivo con il cemento delle pareti.**

The double height tall units are in natural oak,
a finishing that creates a very expressive combination with the cement of the walls.

Les armoires à double hauteur sont en chêne naturel,
une finition qui crée une combinaison très expressive avec le ciment des murs.

Las columnas de doble altura son de roble natural,
un acabado que crea una combinación muy expresiva con el cemento de las paredes.

SCHEDA TECNICA CUCINA . 6
 TECHNICAL SHEET KITCHEN. 6
 FICHE TECHNIQUE CUISINE. 6
 FICHA TÉCNICA DE LA COCINA. 6

APERTURA A GOLA CLASSICA (KYTON)
 OPENING WITH CLASSIC GROOVE (KYTON)
 OUVERTURE AVEC GORGE CLASSIQUE (KYTON)
 APERTURA CON RANURA CLÁSICA (KYTON)

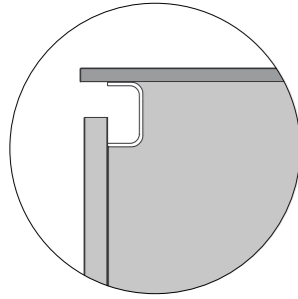

APERTURA A GOLA CLASSICA (FLY)
 OPENING WITH CLASSIC GROOVE (FLY)
 OUVERTURE AVEC GORGE CLASSIQUE (FLY)
 APERTURA CON RANURA CLÁSICA (FLY)

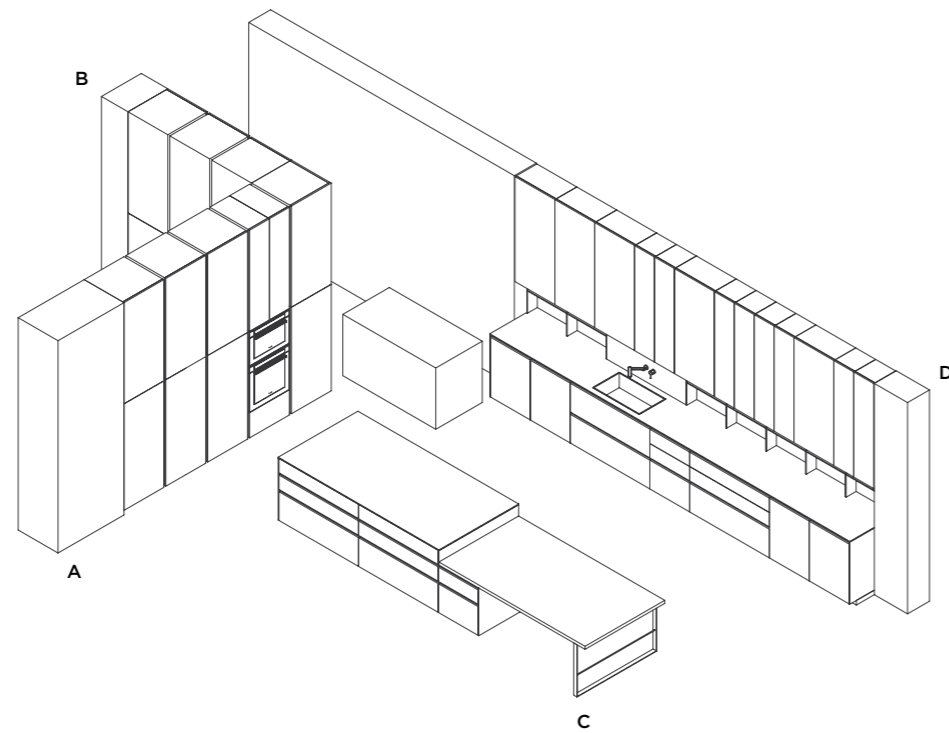
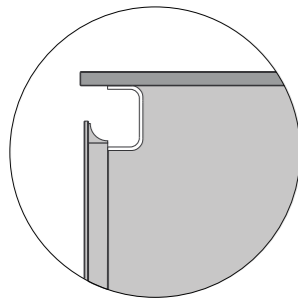

MATERIALI
 MATERIALS
 MATÉRIAUX
 MATERIALES



ROVERE
 NATURALE



VETRO SATINATO
 NERO OPACO

PIANTA
 1 cucina
 2 living
 3 pranzo

LAYOUT
 1 kitchen
 2 living
 3 lunch

LAYOUT
 1 cuisine
 2 séjour
 3 déjeuner

PLANTA
 1 cocina
 2 living
 3 comedor

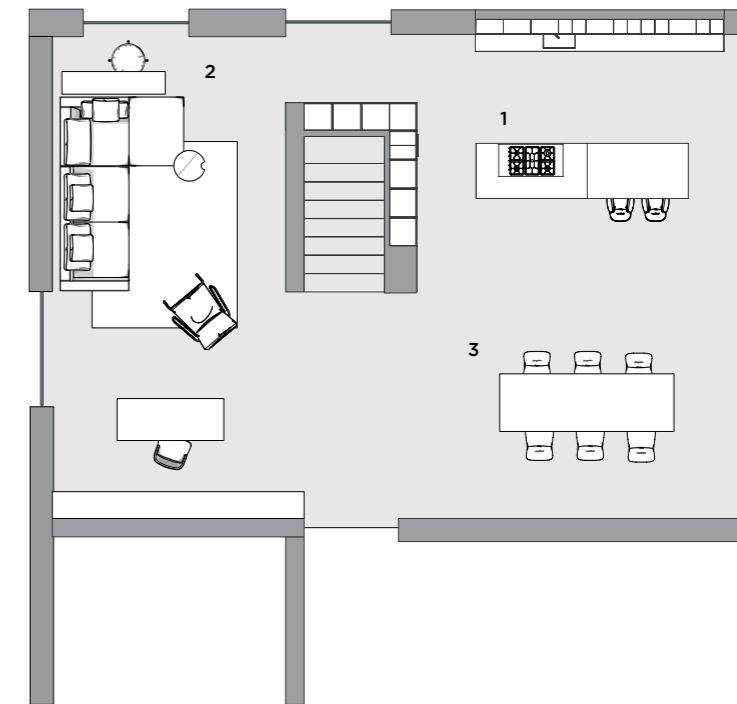

A | COLONNE

tall units
 armoires
 columnas

B | COLONNE

tall units
 armoires
 columnas

C | ISOLA

island
 îlot
 isla

D | BASI E PENSILI

base and wall units
 meubles bas et meubles haut
 bases y elementos colgantes

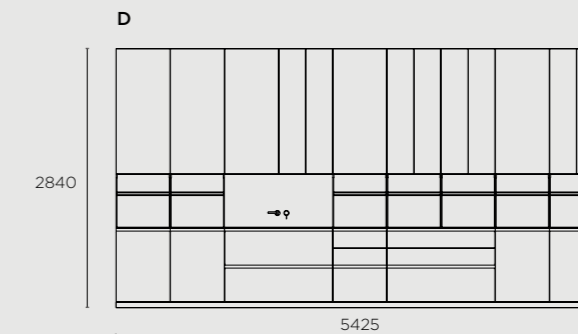
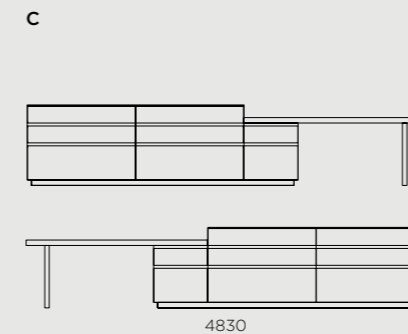
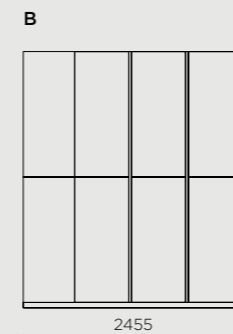
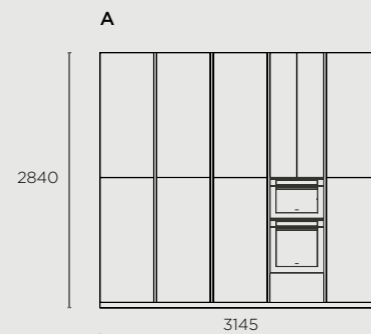





CUCINA . 7 KITCHEN . 7 CUISINE . 7 COCINA . 7

LA VILLA DI UN COMPLESSO RESIDENZIALE MODERNO È CARATTERIZZATA DA AMPIE VETRATE CHE AFFACCIANO SUL RIGOGLIOSO GIARDINO D'INVERNO. LA CUCINA, FULCRO DELLA ZONA GIORNO, SI SVILUPPA A PARETE E A CENTRO STANZA, GRAZIE ALL'ISOLA COLLEGATA DAL PIANO SNACK.

THE VILLA OF A MODERN RESIDENTIAL AREA IS CHARACTERIZED BY LARGE WINDOWS THAT OVERLOOK THE LUSH WINTER GARDEN. THE KITCHEN, THE FULCRUM OF THE LIVING AREA, DEVELOPS ON THE WALL AND IN THE MIDDLE OF THE ROOM, THANKS TO THE ISLAND CONNECTED BY THE SNACK WORKTOP.

LA VILLA D'UN COMPLEXE RÉSIDENTIEL MODERNE EST CARACTÉRISÉE PAR DE GRANDES BAIES VITRÉES QUI DONNENT SUR LE JARDIN D'HIVER LUXURIANT. LA CUISINE, POINT D'APPUI DU SALON, SE DÉVELOPPE SUR LE MUR ET AU MILIEU DE LA PIÈCE, GRÂCE À L'ÎLOT RELIÉ PAR LE PLAN SNACK.

EL CHALET DE UN COMPLEJO RESIDENCIAL MODERNO SE CARACTERIZA POR CRISTALERAS AMPLIAS, QUE DAN A UN JARDÍN FRONDOSO DE INVIERNO. LA COCINA, EL EJE DE LA ZONA DE DÍA, SE DESARROLLA EN LA PARED Y EN EL CENTRO DE LA HABITACIÓN MEDIANTE LA ISLA CONECTADA A LA BARRA.





Il piano snack in rovere torba congiunge l'isola alle basi a parete in laccato grigio fossile con top e boiserie in pietra piasentina spazzolata.

The peat oak snack woktop connects the island to the wall units in gray fossil lacquer with top and brushed piasentina stone boiserie.

Le plan snack en chêne tourbe joint l'îlot aux meubles base laqués gris fossile avec plan et boiserie en pierre piasentina brossé.

La barra de roble turba une la isla con las bases murales lacadas en gris fósil con encimera y boiserie de piedra Piasentina cepillada.





Nelle colonne, l'anta in vetro fumé e telaio in alluminio nero si apre sull'interno in rovere torba, stessa finitura usata per colonne, pensili e piano snack.

In the tall units, the door with brown frame and smoked glass opens on the inside in peat oak, the same finishing used for tall units, wall units and snack worktop.

Dans les armoires, la porte avec cadre brun et verre fumé s'ouvre à l'intérieur en chêne tourbe, la même finition utilisée pour les armoires, meubles haut et plan snack.

En las columnas, la puerta con estructura marrón y cristal ahumado se abre mostrando el interior de roble turba, con el mismo acabado usado para columnas, elementos colgantes y barra.

SCHEDA TECNICA CUCINA . 7
 TECHNICAL SHEET KITCHEN . 7
 FICHE TECHNIQUE CUISINE . 7
 FICHA TÉCNICA DE LA COCINA . 7

APERTURA SISTEMA TELAIO
 FRAME SYSTEM OPENING
 OUVERTURE DU SYSTÈME DE CADRE
 SISTEMA DE MARCO DE APERTURA

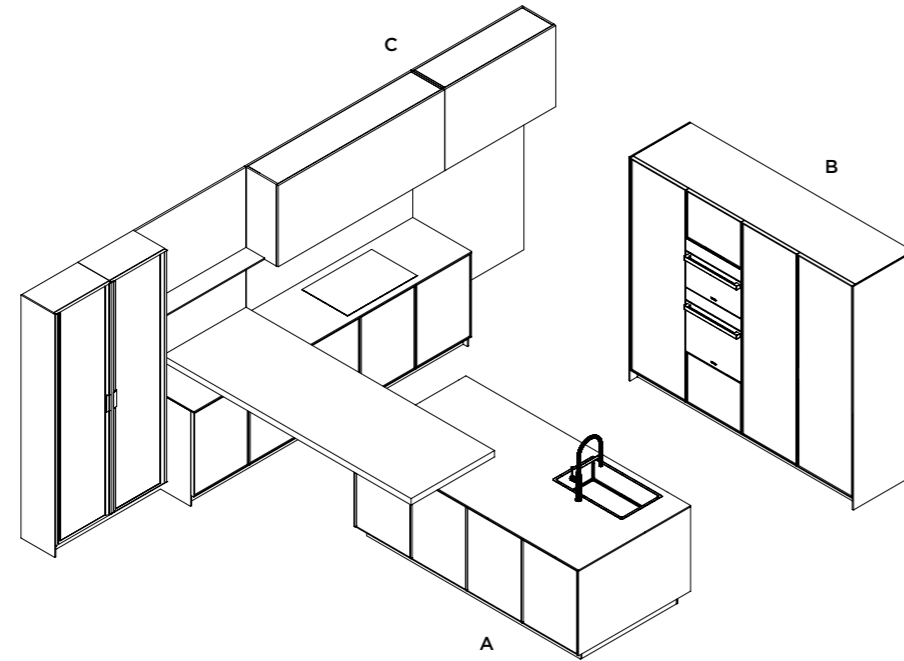
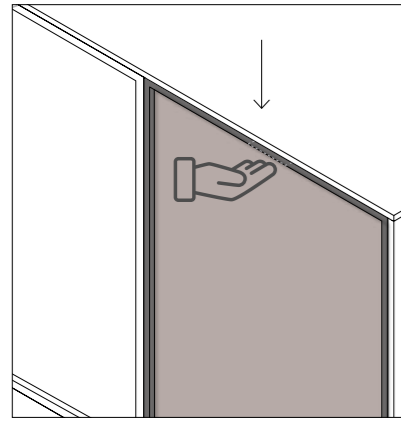
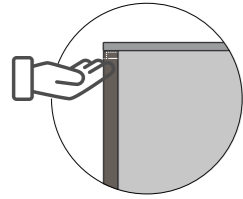

MATERIALI
 MATERIALS
 MATÉRIAUX
 MATERIALES



LACCATO OPACO
GRIGIO FOSSILE

ROVERE TORBA

PIETRA PIASENTINA

PIANTA
 1 cucina
 2 living
 3 pranzo

LAYOUT
 1 kitchen
 2 living
 3 lunch

LAYOUT
 1 cuisine
 2 séjour
 3 déjeuner

PLANTA
 1 cocina
 2 living
 3 comedor

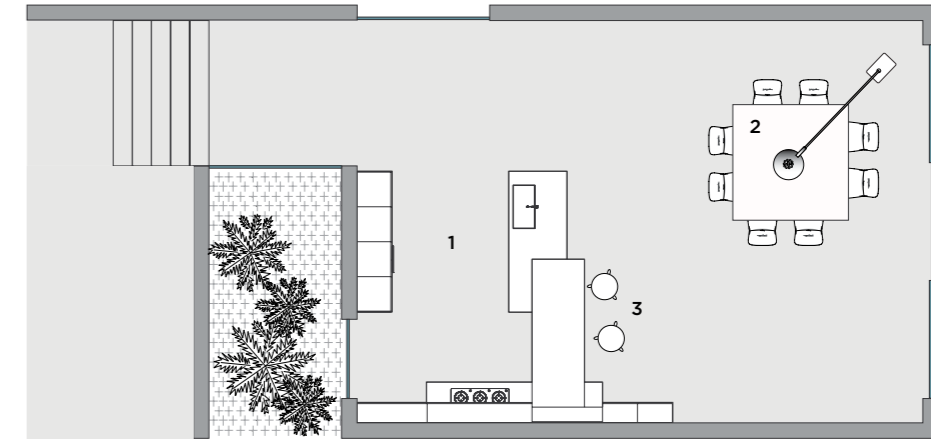

A | ISOLA

island
 îlot
 isla

B | COLONNE

tall unit
 armoires
 columnas

C | BASI A PARETE

base units
 meubles bas
 bases murale

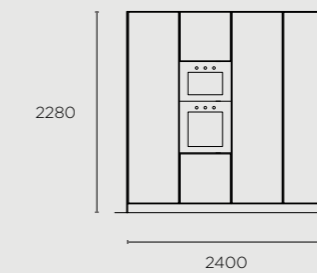
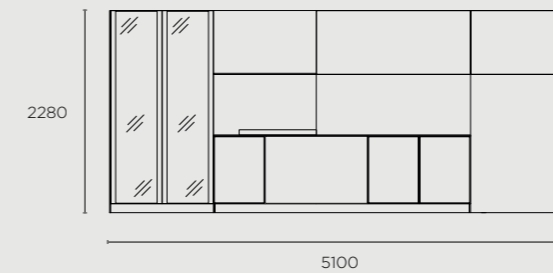
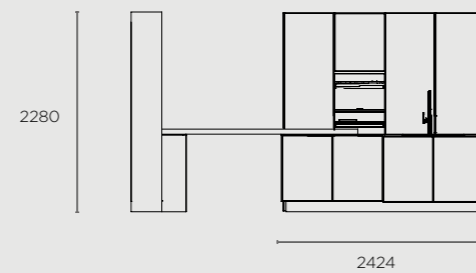

ZONA GIORNO
LIVING
SÉJUR
ZONA DE DÍA





Sulla parete rivestita di grès calacatta spiccano le mensole e i pensili sospesi in noce e le basi in laccato opaco bianco ghiaccio.

On the wall covered with grès calacatta stand out the shelves and suspended wall units in walnut and matt white ice lacquered.

Sur le mur recouvert de grès calacatta brillent les étagères et les meubles haut suspendus en noyer et laqué mat en blanc glace.

En la pared, revestida con gres Calacatta, destacan las ménsulas y los elementos colgantes de nogal y lacados en blanco mate hielo.



SCHEDA TECNICA ZONA GIORNO . 1
 TECHNICAL SHEET LIVING AREA. 1
 FICHE TECHNIQUE ZONE DE VIE. 1
 FICHA TÉCNICA DE LA ZONA DE DÍA. 1

APERTURA PUSH-PULL
 OPENING WITH PUSH-PULL
 OUVERTURE AVEC PUSH-PULL
 APERTURA PUSH-PULL

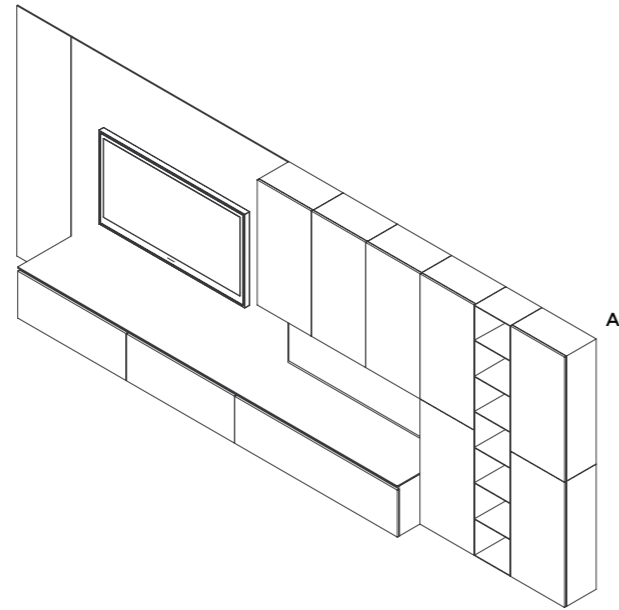
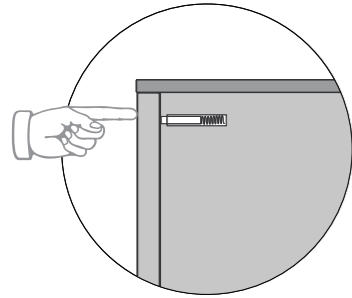

MATERIALI
 MATERIALS
 MATÉRIAUX
 MATERIALES



LACCATO OPACO
BIANCO GHIACCIO 200



NOCE CANALETTO

PIANTA
1 cucina
2 living
3 pranzo
4 terrazzo

LAYOUT
 1 kitchen
 2 living
 3 lunch
 4 terrace

LAYOUT
 1 cuisine
 2 séjour
 3 déjeuner
 4 terrasse

PLANTA
 1 cocina
 2 living
 3 comedor
 4 terraza

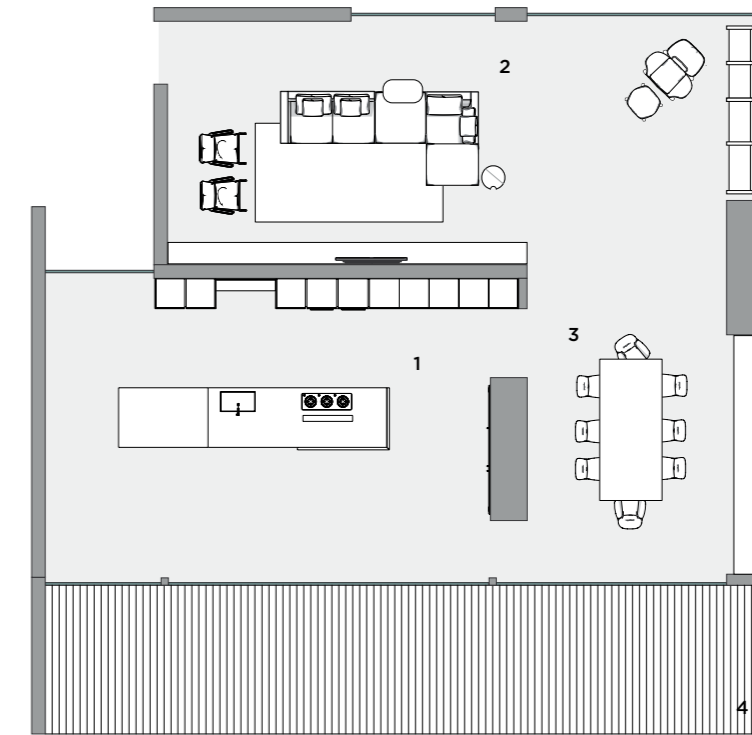

A | BASI, COLONNE E PENSILI SOSPESI

base, tall and suspended tall units
 meubles bas, armoires et meubles haut suspendus
 bases, columnas y elementos colgantes

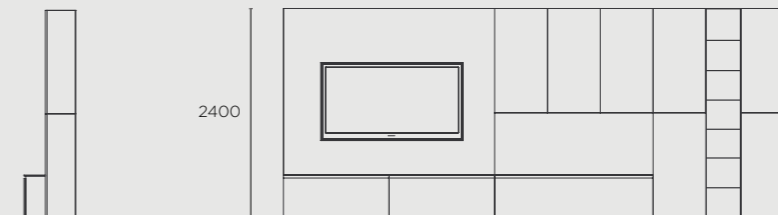





Posizionata tra le basi a terra e i pensili sospesi con vani a giorno, la mensola con schienale in legno di briccola è un'ottima soluzione home office.

Positioned between the base units and suspended wall units with open elements, the shelf with briccola wood backrest is an excellent home office solution.

Positionné entre les meubles bas au sol et les meubles haut suspendus avec les éléments ouverts, l'étagère avec crédence en bois de briccola est une excellente solution de bureau à la maison.

La ménsula con respaldo de madera de briccola, situada entre las bases en el suelo y los elementos colgantes abiertos, es una solución óptima como home office.

SCHEMA TECNICA ZONA GIORNO . 2

TECHNICAL SHEET LIVING AREA . 2
 FICHE TECHNIQUE ZONE DE VIE. 2
 FICHA TÉCNICA DE LA ZONA DE DÍ. 2

APERTURA PUSH-PULL
 OPENING WITH PUSH-PULL
 OUVERTURE AVEC PUSH-PULL
 APERTURA PUSH-PULL

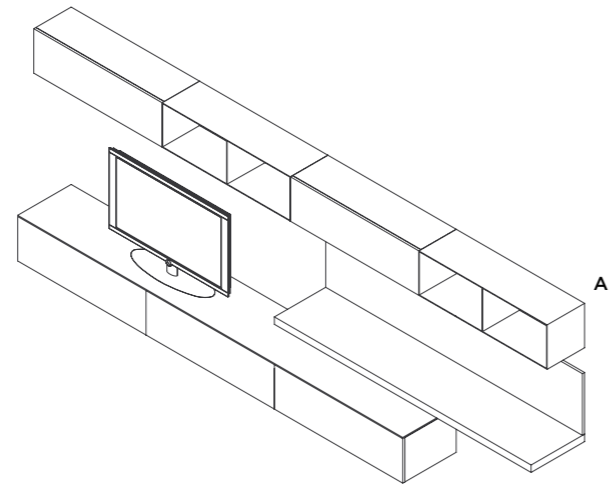
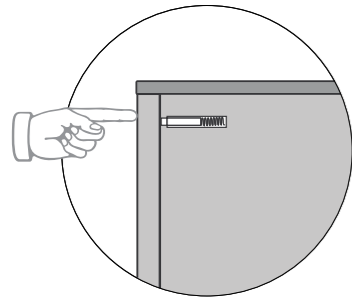

MATERIALI
 MATERIALS
 MATÉRIAUX
 MATERIALES



LACCATO OPACO
 BIANCO SOFT 201



LEGNO DI BRICCOLA
 NATURALE

PIANTA
 1 cucina
 2 living
 3 pranzo
 4 terrazzo

LAYOUT
 1 kitchen
 2 living
 3 lunch
 4 terrace

LAYOUT
 1 cuisine
 2 séjour
 3 déjeuner
 4 terrasse

PLANTA
 1 cocina
 2 living
 3 comedor
 4 terraza

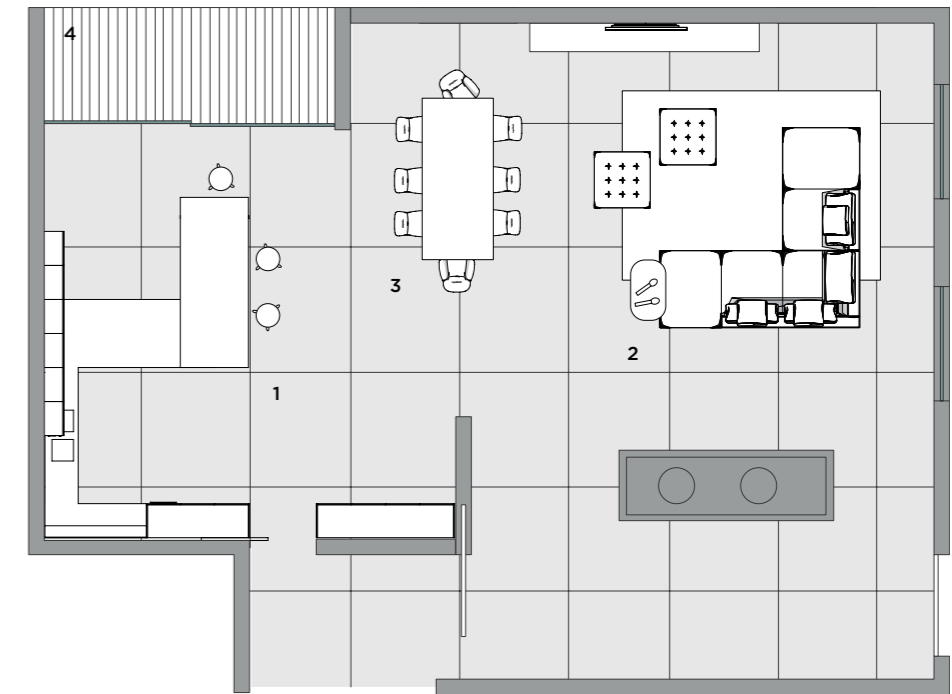

A | BASI A TERRA E PENSILI

base units on the ground and wall units
 meubles bas et meubles haut
 bases inferiores y elementos colgantes

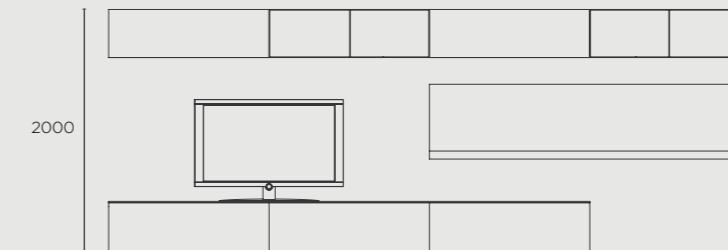
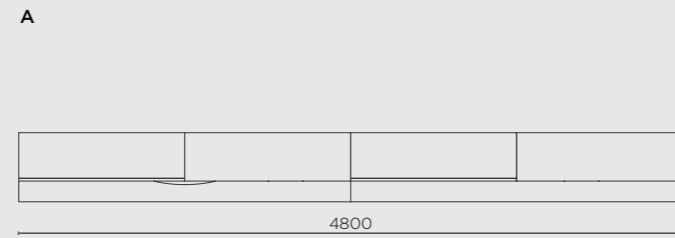





I pensili in abete moka sono montati a filo con la struttura architettonica che ospita il camino in etanolo: una soluzione su misura di grande impatto per la zona giorno.

The moka fir wall units are flush with the architectural structure that houses the ethanol fireplace : a bespoke solution of great impact for the living area.

Les meubles haut en moka sapin montés au ras de la structure architecturale qui abrite la cheminée à l'éthanol: une solution sur mesure d'un grand impact sur l'espace de vie.

Los elementos colgantes de abeto moka están montados a ras de la estructura arquitectónica, que aloja la chimenea de etanol: una solución a medida con un gran impacto para la zona de día.

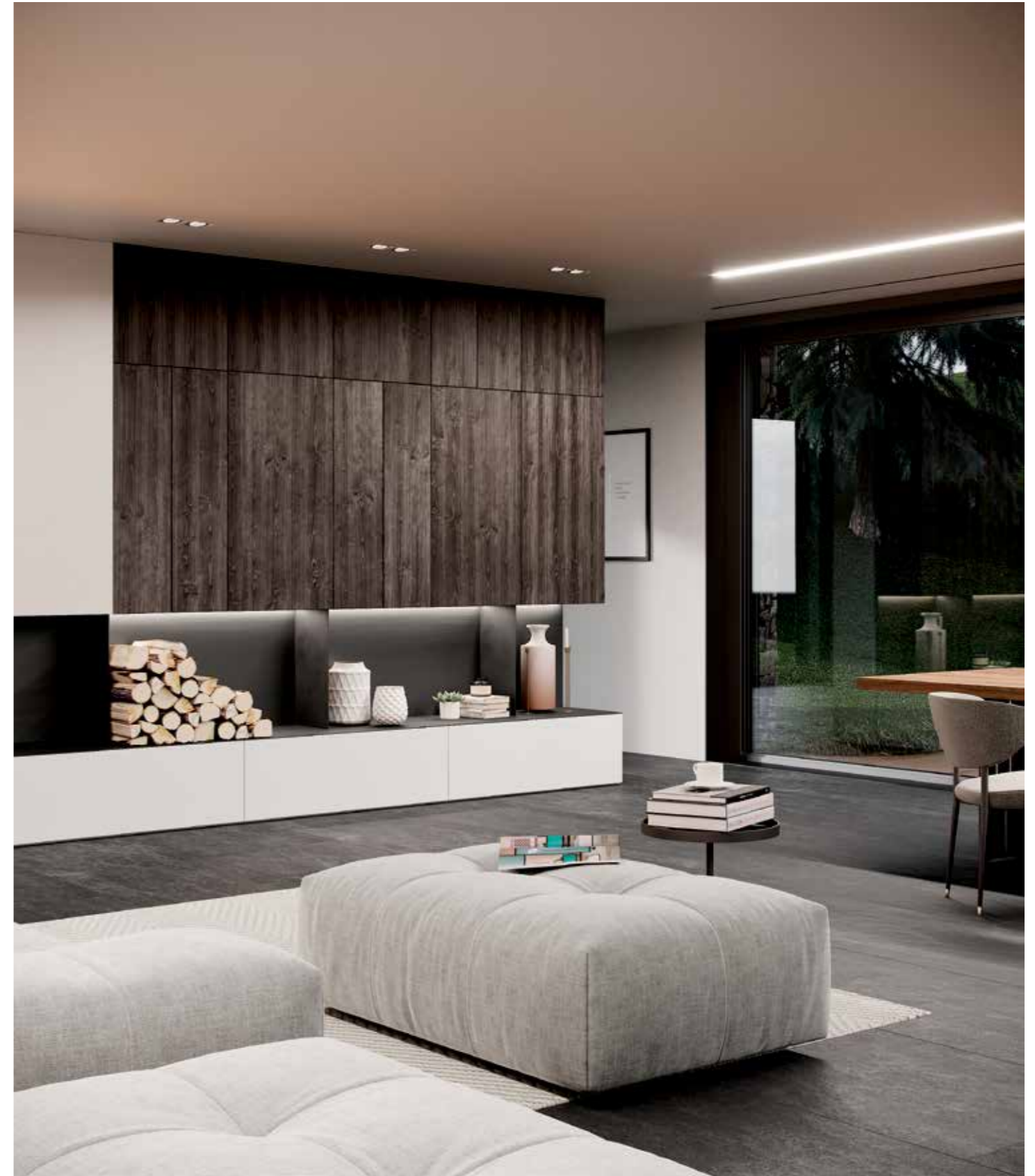

SCHEDA TECNICA ZONA GIORNO . 3
 TECHNICAL SHEET LIVING AREA. 3
 FICHE TECHNIQUE ZONE DE VIE. 3
 FICHA TÉCNICA DE LA ZONA DE DÍA. 3

APERTURA PUSH-PULL
 OPENING WITH PUSH-PULL
 OUVERTURE AVEC PUSH-PULL
 APERTURA PUSH-PULL

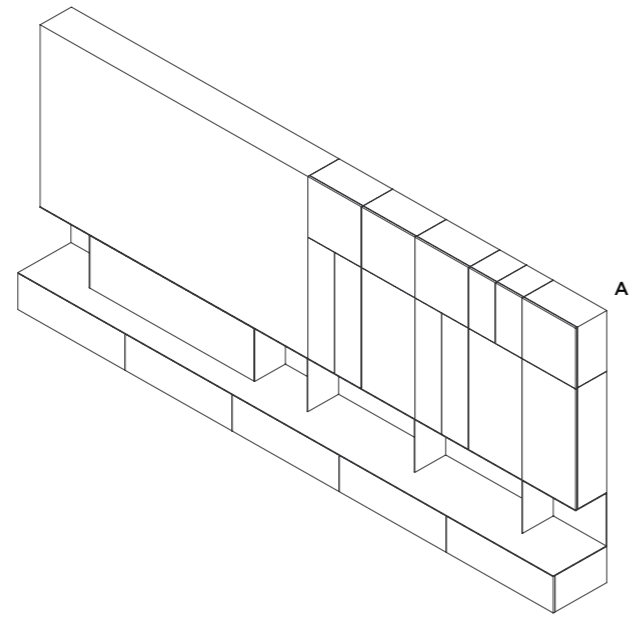
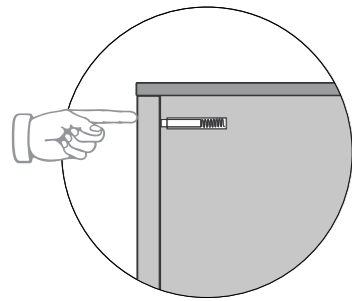

MATERIALI
 MATERIALS
 MATÉRIAUX
 MATERIALES



LACCATO OPACO
 BIANCO TRAFFICO 9016



ABETE MOKA

PIANTA
 1 cucina
 2 living
 3 pranzo
 4 terrazzo

LAYOUT
 1 kitchen
 2 living
 3 lunch
 4 terrace

LAYOUT
 1 cuisine
 2 séjour
 3 déjeuner
 4 terrasse

PLANTA
 1 cocina
 2 living
 3 comedor
 4 terraza

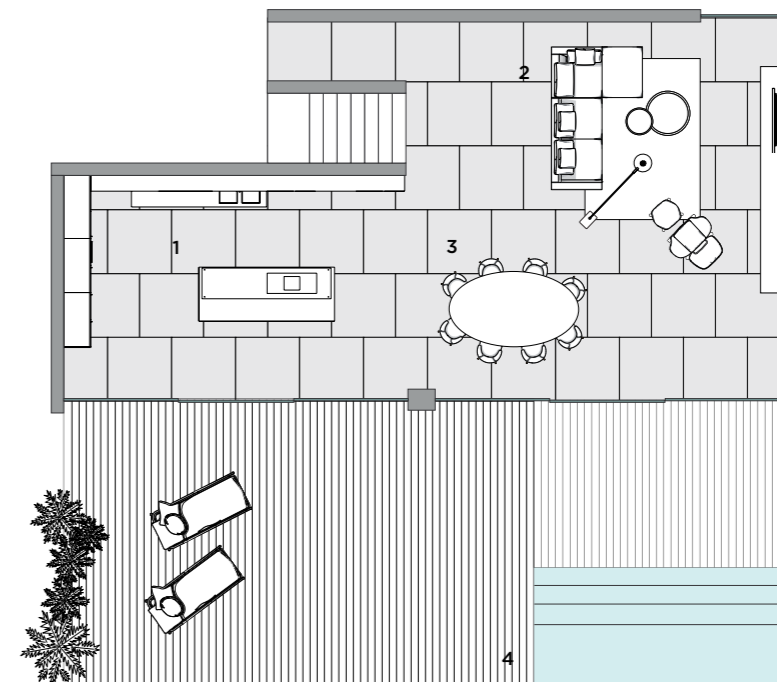

A | BASI A TERRA E PENSILI

base units on the ground and wall units
 meubles bas au sol et meubles haut
 bases inferiores y elementos colgantes

A

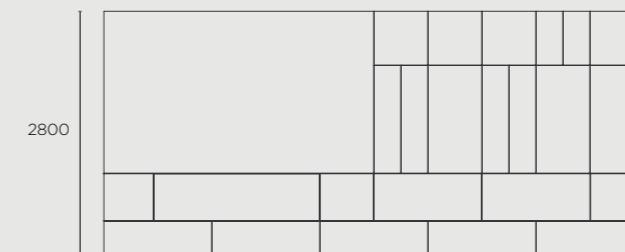

KYTON

ANTE E DETTAGLI TECNICI

DOORS AND TECHNICAL DETAILS
PORTES ET DÉTAILS TECHNIQUES
PUERTAS Y DETALLES TÉCNICOS

Kyton è un programma molto versatile che si può personalizzare con cinque sistemi di apertura: la gola classica in alluminio, che crea giochi d'ombra e profondità; la gola piatta, più contemporanea; la maniglia e la maniglia scavata, che diventano un dettaglio di stile; l'apertura push-pull, per una pulizia assoluta.

Kyton is a very versatile door that can be customized with five opening systems: the classic aluminum groove, which creates plays of shadows and depth; the flat groove, more contemporary, characterized by the door worked at 30 °; the handle and the built-in handle on the lacquered door, which becomes a style detail, the push-pull opening, for an absolute cleaning.

Kyton est une porte très éclectique qui peut être personnalisée avec cinq systèmes d'ouverture: la gorge classique en aluminium, qui crée des jeux d'ombres et de profondeur; la gorge plate, plus contemporaine, caractérisée par la porte travaillée à 30 °; la poignée, qui devient un détail de style; la poignée encastrée sur la porte laquée; l'ouverture push-pull, pour un nettoyage absolu.

Kyton es una puerta muy versátil, personalizable con cinco sistemas de apertura: la clásica ranura de aluminio, que crea juegos de sombras y profundidades; la ranura plana, más actual, caracterizada por la puerta labrada a 30°; el tirador, convertido en un elemento de estilo; el tirador cóncavo en la puerta lacada; la apertura push-pull para una limpieza absoluta.

Apertura a gola classica

Opening with classic groove
Ouverture avec gorge classique
Apertura con ranura clásica

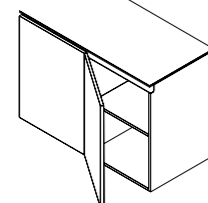
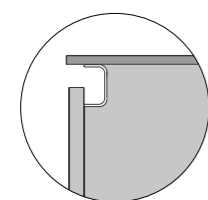

Apertura a gola piatta

Opening with flat groove
Ouverture avec gorge plate
Apertura con ranura plana

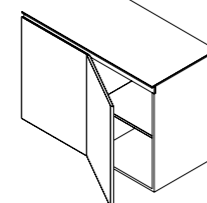
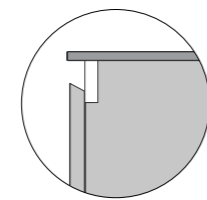

Apertura con maniglia

Opening with handle
Ouverture avec poignée
Apertura con tirador

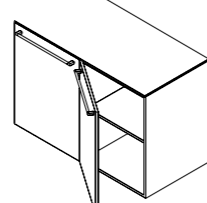
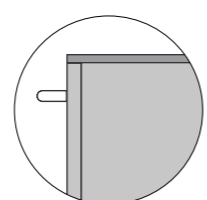

Apertura con maniglia scavata

Opening with built-in handle
Ouverture avec poignée encastrée
Apertura con tirador cóncavo

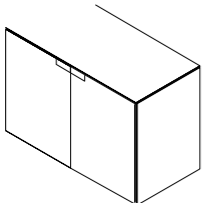
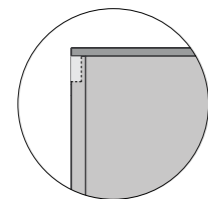

Apertura push-pull

Opening with push-pull
ouverture avec push-pull
apertura push-pull

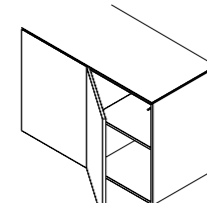
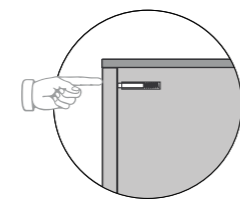

Apertura sistema telaio

Frame system opening
Ouverture du système de cadre
Sistema de marco de apertura

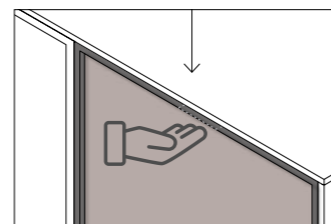
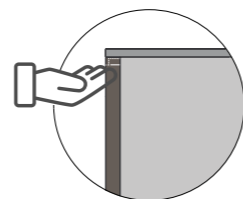

FLY

ANTE E DETTAGLI TECNICI

DOORS AND TECHNICAL DETAILS
PORTES ET DÉTAILS TECHNIQUES
PUERTAS Y DETALLES TÉCNICOS

Estremamente evoluta dal punto di vista tecnico, l'anta Fly è realizzata unendo un telaio leggero in alluminio e un pannello in vetro - lucido o opaco - spesso 4 mm. Leggerissima, facile da pulire e resistente, è disponibile con apertura a gola classica.

Extremely advanced from a technical point of view, the Fly door is made by joining a lightweight aluminum frame and a glass panel - glossy or mat - 4 mm thick. Lightweight, easy to clean and resistant, it is available with classic groove opening.

Extrêmement avancée d'un point de vue technique, la porte Fly est réalisée en joignant un cadre en aluminium léger et un panneau de verre - brillant ou mat - de 4 mm d'épaisseur. Très léger, facile à nettoyer et résistant, il est disponible avec ouverture gorge classique.

La puerta Fly, sumamente avanzada desde el punto de vista técnico, se ha realizado combinando una estructura ligera de aluminio y un panel de cristal - brillante o mate - de 4 mm de grosor. Muy ligera, fácil de limpiar y resistente, existe con apertura con ranura clásica.

A - profilo per apertura

groove for opening
gorge pour ouverture
ranura para apertura

B - telaio in alluminio

aluminium frame
cadre en aluminium
estructura de aluminio

C - vetro temperato trasparente o acidato, laccato sul retro

transparent or etched tempered glass, lacquered on the back
verre trempé transparent ou dépoli, laqué sur le dos
cristal templado transparente o al ácido, lacado en la parte tra sera

Apertura a gola classica

Grip profile
Ouverture avec gorge classique
Apertura con ranura clásica

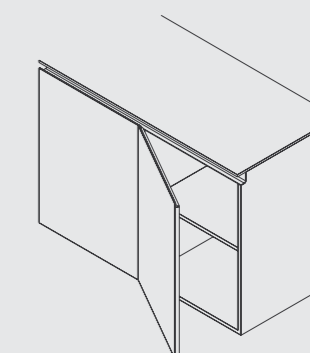
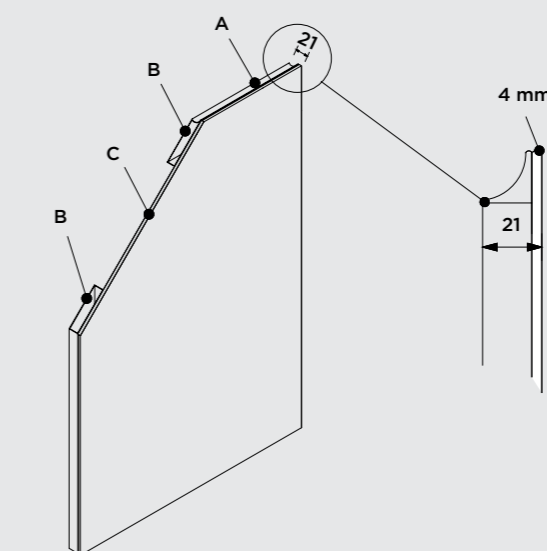
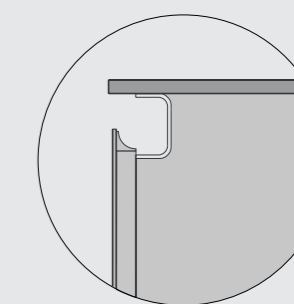

MATERIALI KYTON MATERIALS

FENIX NTM®

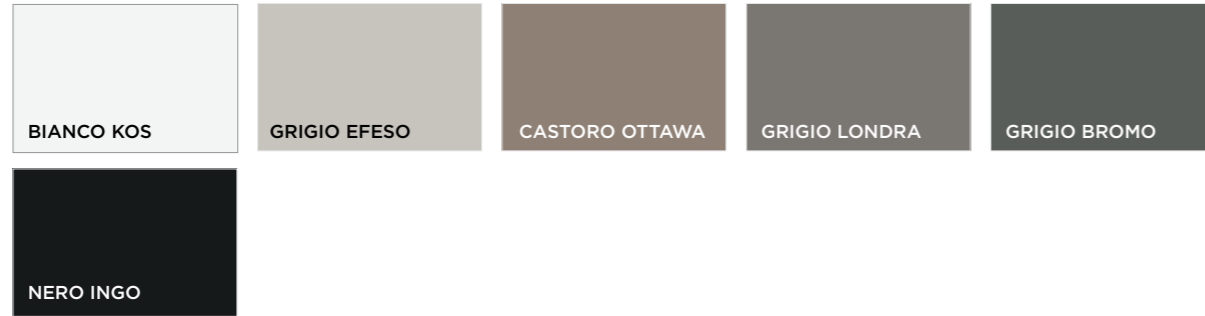

LACCATI OPACHI E LUCIDI MAT AND GLOSSY LACQUERED LAQUÉS MATS ET BRILLANTS LACADOS MATES Y BRILLANTES



LACCATO METALLO METAL LACQUERED LAQUE' MÉTAL LACADO METAL

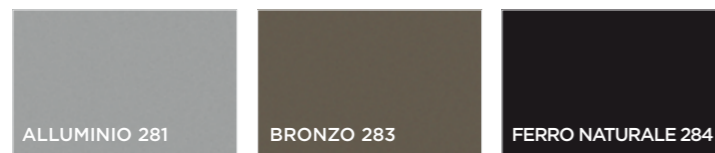

LACCATO OSSIDATO OXIDIZED LACQUERED LAQUE' OXYDÉ LACADO OXIDADO



ROVERE FIAMMATO FLAMED OAK CHÊNE FLAMMÉ ROBLE FIAMMATO

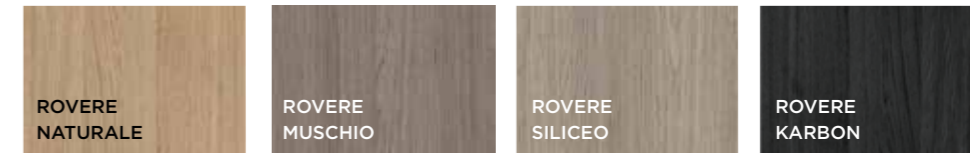

ROVERE NODATO KNOTTED OAK CHÊNE AVEC NOEUDS ROBLE NODATO

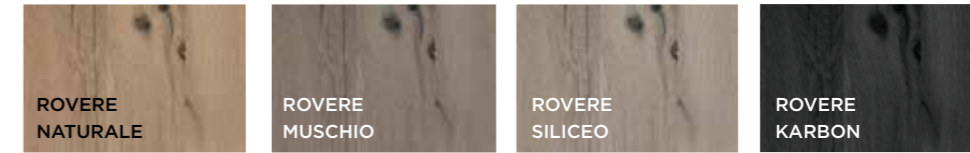

ROVERE TERMOCOTTO THERMO COOKED OAK CHÊNE THERMO-CUIT ROBLE TERMOCOCIDO

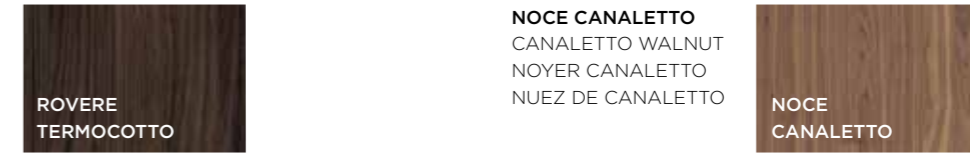

ROVERE OLD OLD OAK CHÊNE OLD ROBLE ANTIGUO

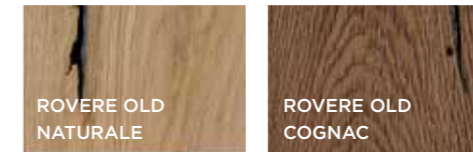

ABETE FIR SAPIN ABETO



RESINA CEMENTO CEMENT RESIN RÉSINE CIMENT RESINA CEMENTO

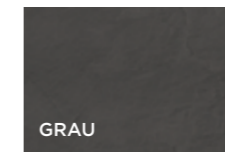

RESINA CEMENTO OSSIDI CEMENT RESIN "OSSIDI" RÉSINE CIMENT "OSSIDI" RESINA CEMENTO ÓXIDOS



MATERIALI FLY MATERIALS

VETRO OPACO E LUCIDO MAT AND GLOSSY GLASS VERRE MAT ET BRILLANT CRISTAL MATE Y BRILLANTE

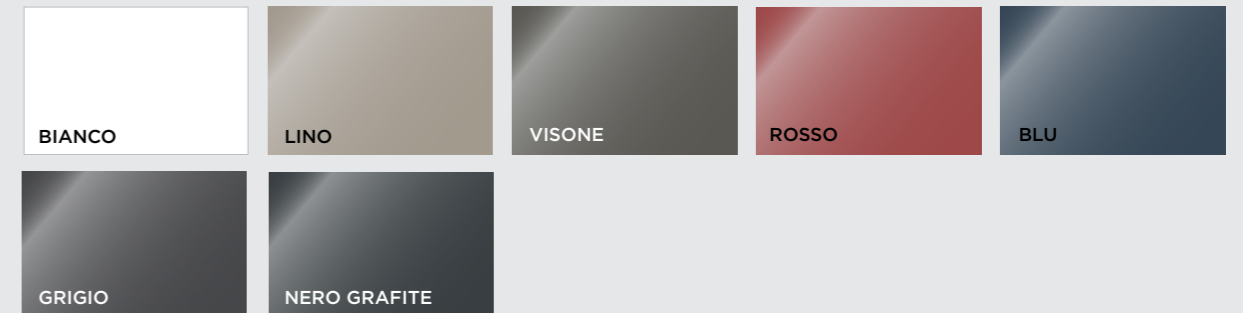

CONCEPT
R&S Nova Cucina

DIGITAL IMAGES
imagodesign

GRAPHIC DESIGN
imagodesign

COPYWRITING
Lisa Cadamuro

PRINTING
Grafiche Italprint

2018

Nova Cucina S.r.l.

Via Tessere, 8 • 33070 San Giovanni di Polcenigo
Pordenone • Italy
Tel. +39 0434 748791
Fax +39 0434 74077

www.novacucina.com
info@novacucina.com

